

24.0" CHASSIS MOUNT (Monitor or Panel Computer)

PRELIMINARY DRAWING
DIMENSIONS ARE SUBJECT TO CHANGE

REVISION HISTORY			
REV	DATE	INITIALS	DESCRIPTION
00	11/27/19	MAW	INITIAL RELEASE

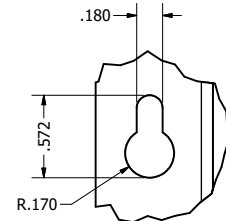
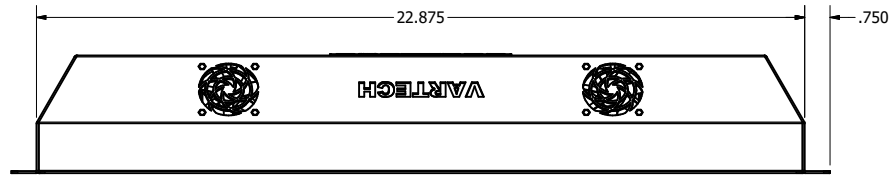

DETAIL A

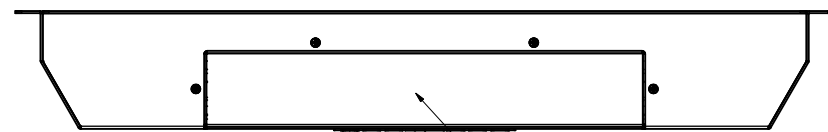
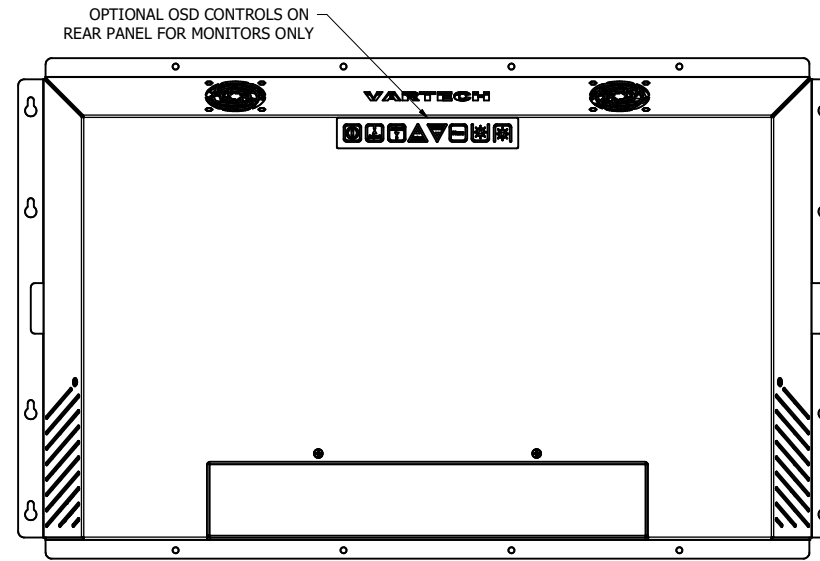
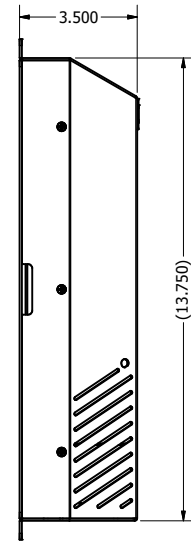
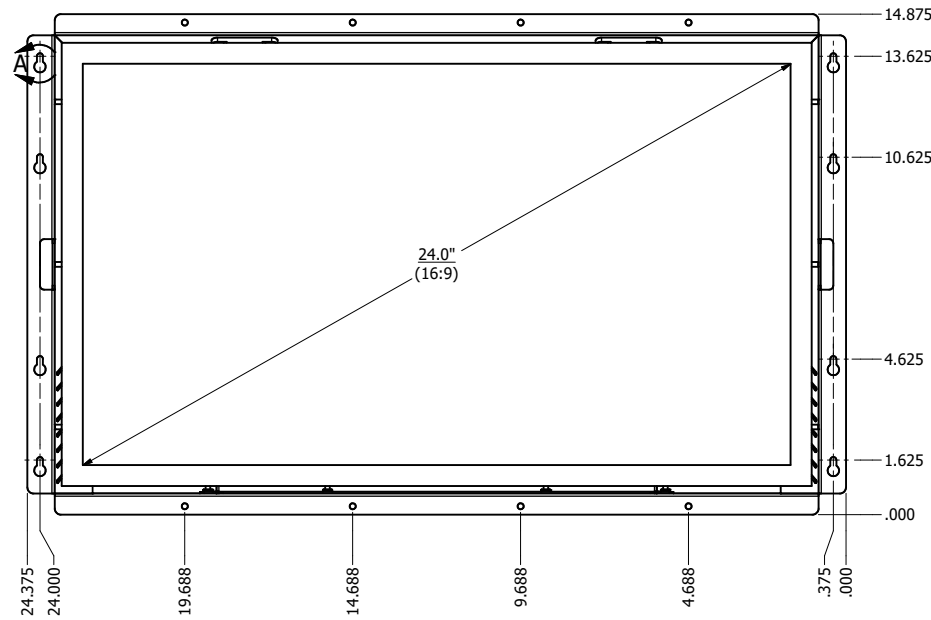
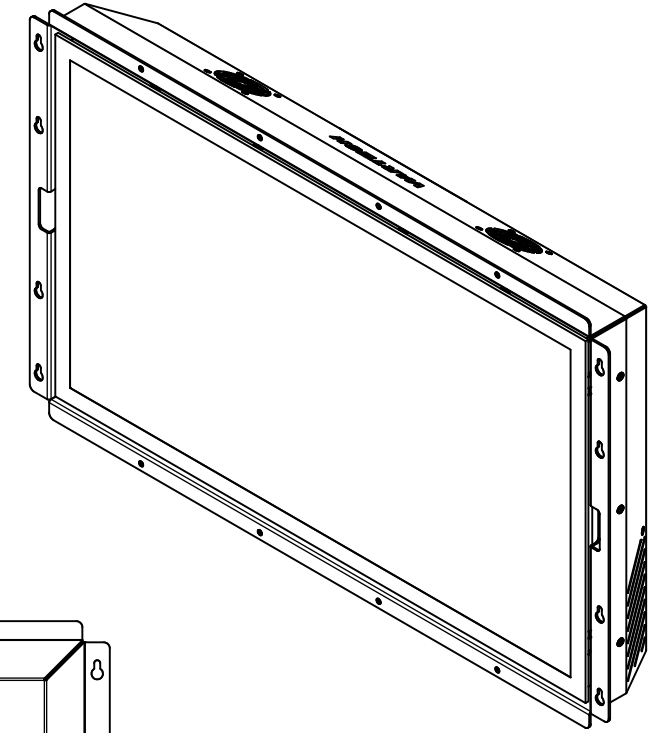

SEVERAL I/O AND POWER CONFIGURATIONS AVAILABLE

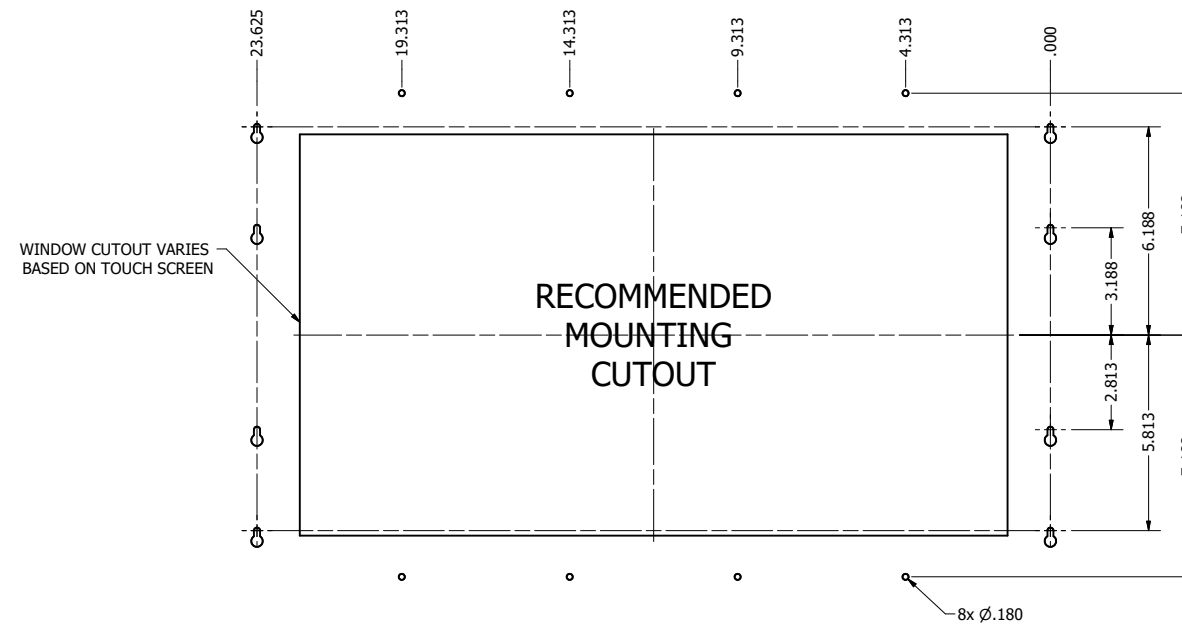

DRAWN BY: mwitham		8/18/2020			
USE WITH PRODUCT NUMBER					
MATERIAL & FINISH				TITLE	
				OUTLINE DRAWING	
				DIAMONDVUE 4	
SHEET	SIZE	PART NUMBER	REV		
6 of 6	D	VTDV4#240bCHA	00		
TOLERANCES: .XX=.01 .XXX=.005					