

17.0" CHASSIS MOUNT (Monitor or Panel Computer)

PRELIMINARY DRAWING  
DIMENSIONS ARE SUBJECT TO CHANGE

REVISION HISTORY			
REV	DATE	INITIALS	DESCRIPTION
00	11/27/19	MAW	INITIAL RELEASE

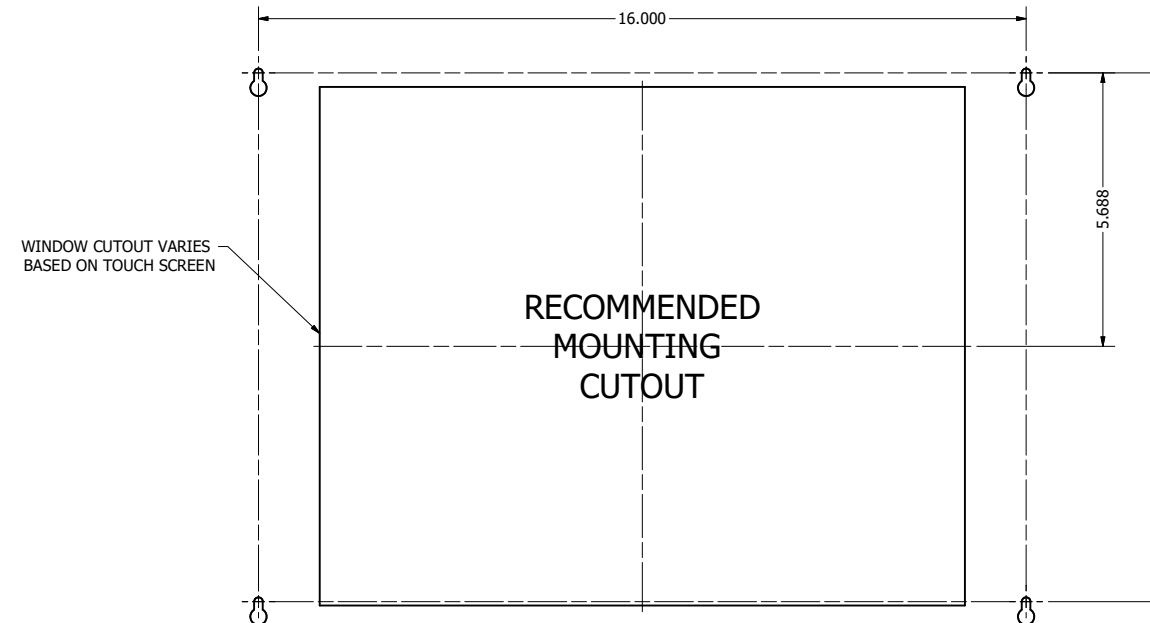
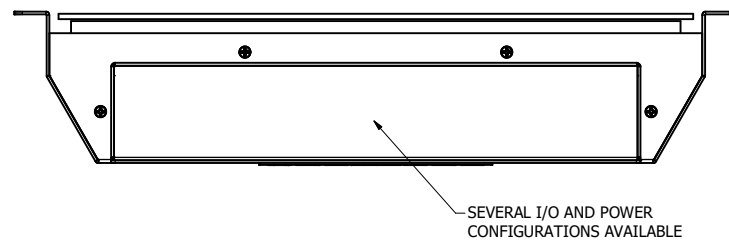
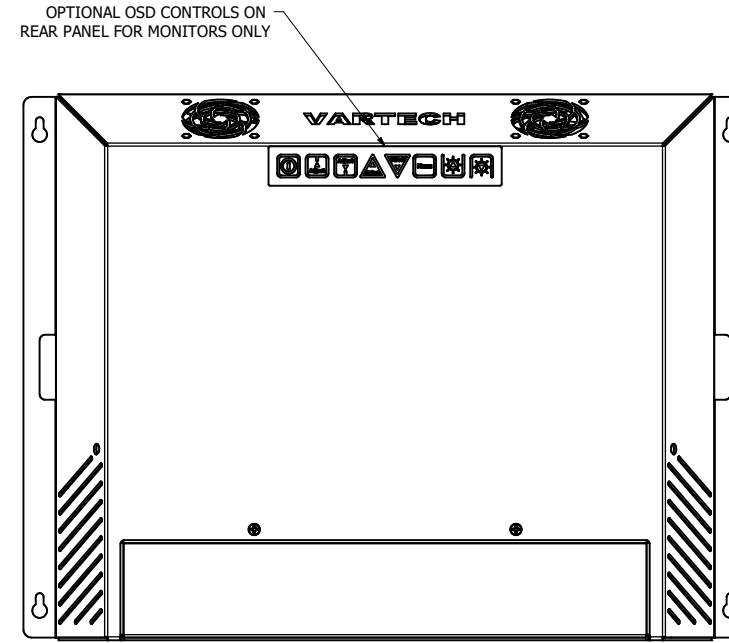
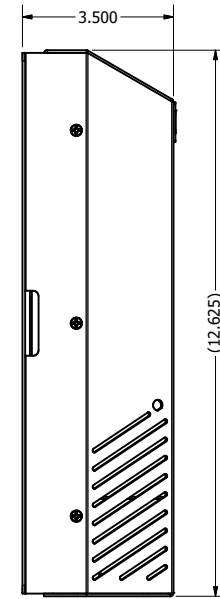
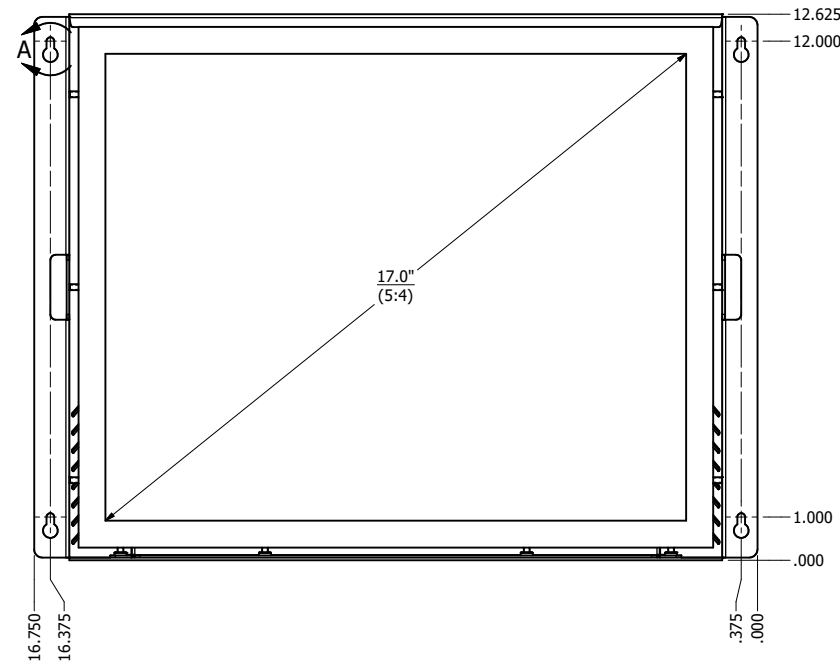
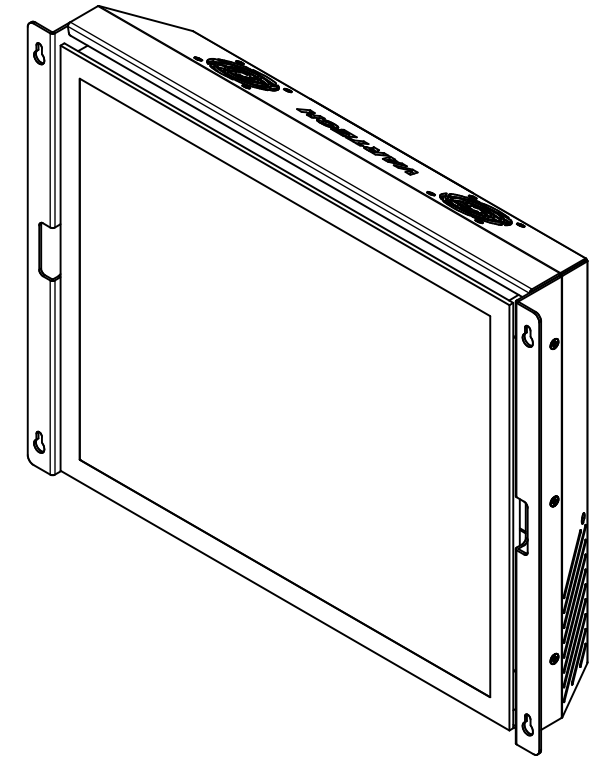
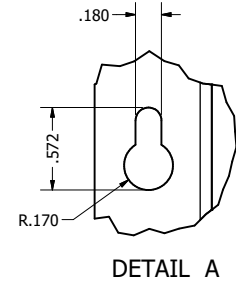
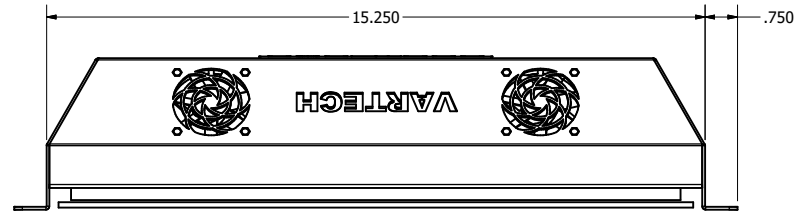

DRAWN BY: mwitham		8/18/2020			
USE WITH PRODUCT NUMBER					
MATERIAL & FINISH				TITLE	
				OUTLINE DRAWING	
				DIAMONDVUE 4	
SHEET	SIZE	PART NUMBER	REV		
7 of 7	D	VTDV4#170dCHA	00		
TOLERANCES: .XX=.01 .XXX=.005					