

27.0" CLIP MOUNT (Monitor or Panel Computer)

PRELIMINARY DRAWING
DIMENSIONS ARE SUBJECT TO CHANGE

| REVISION HISTORY | | | |
|------------------|-----------|----------|-----------------|
| REV | DATE | INITIALS | DESCRIPTION |
| 00 | 2/18/2021 | MAV | INITIAL RELEASE |

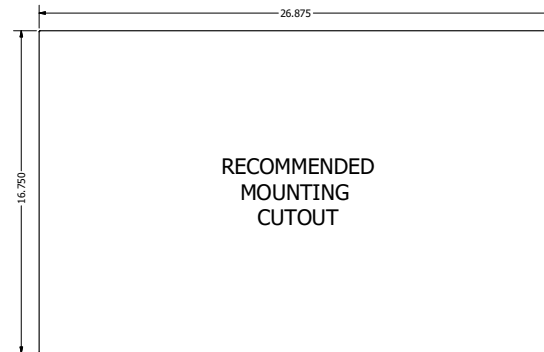
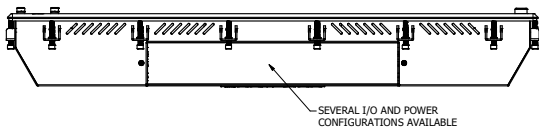
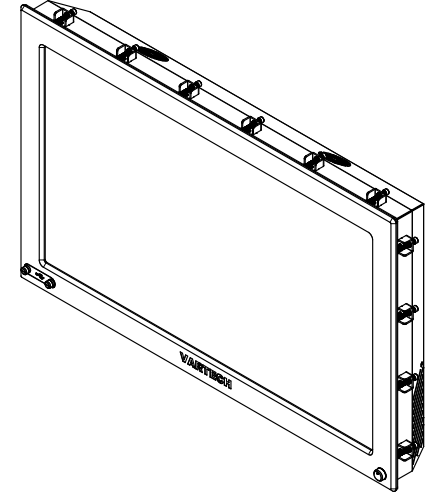
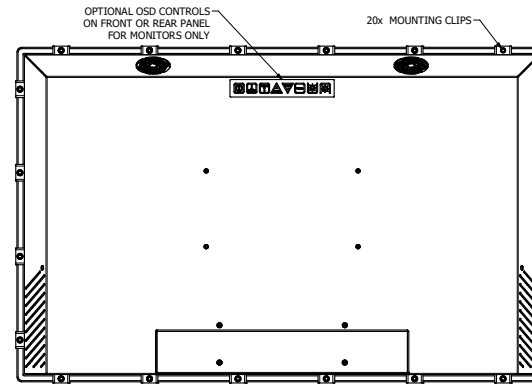
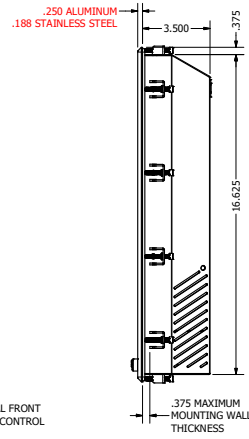
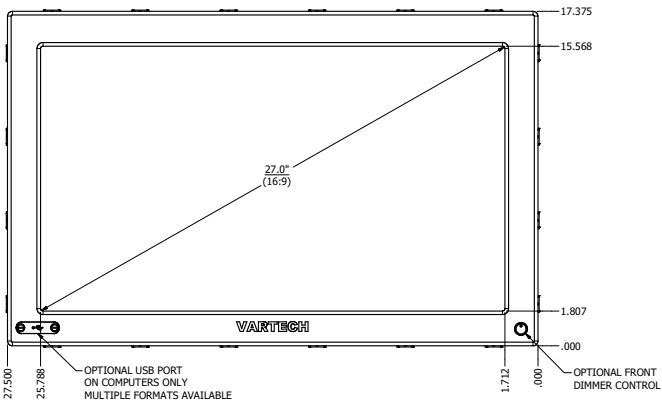
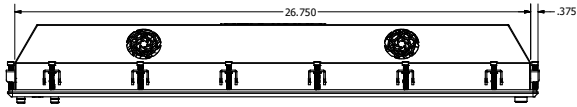

| | | | |
|-------------------------------|------|-----------------|-----|
| DRAWN BY: mivlham | | 11/26/2019 | |
| USE WITH PRODUCT NUMBER | | | |
| MATERIAL & FINISH | | TITLE | |
| | | OUTLINE DRAWING | |
| | | DIAMONDVUE 4 | |
| SHEET | SIZE | PART NUMBER | REV |
| 5 OF 5 | D | VTDV4#270bCP# | 00 |
| TOLERANCES: .XX=.01 .XXX=.005 | | | |

