

12.1" CHASSIS MOUNT (Monitor or Panel Computer)

PRELIMINARY DRAWING
DIMENSIONS ARE SUBJECT TO CHANGE

REVISION HISTORY			
REV	DATE	INITIALS	DESCRIPTION
00	11/27/19	MAW	INITIAL RELEASE

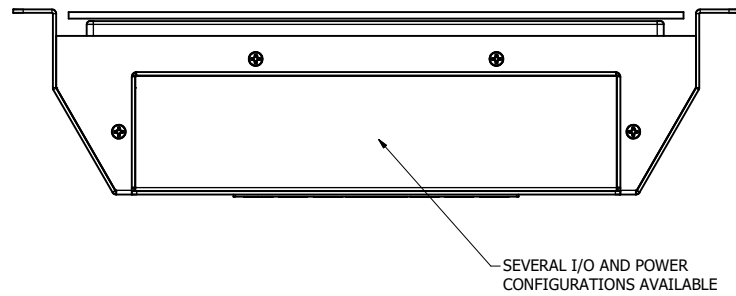
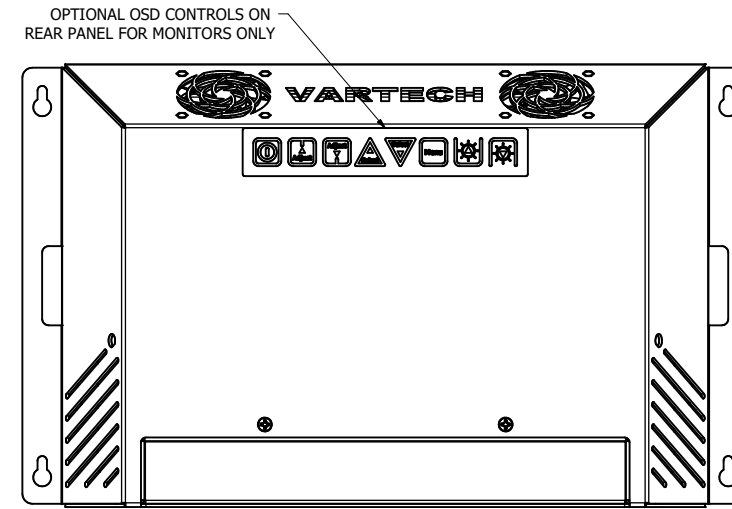
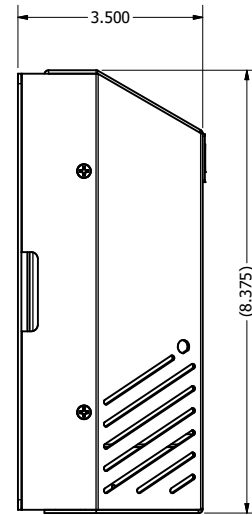
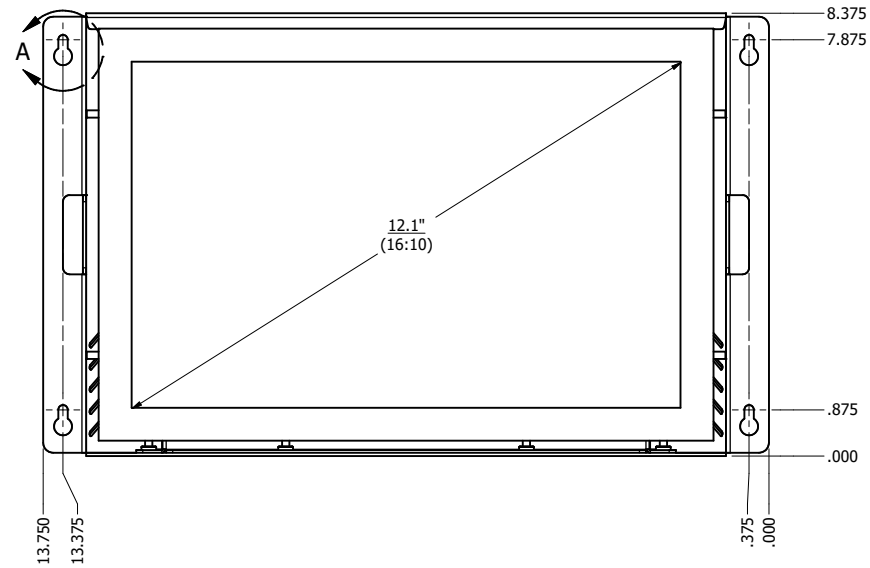
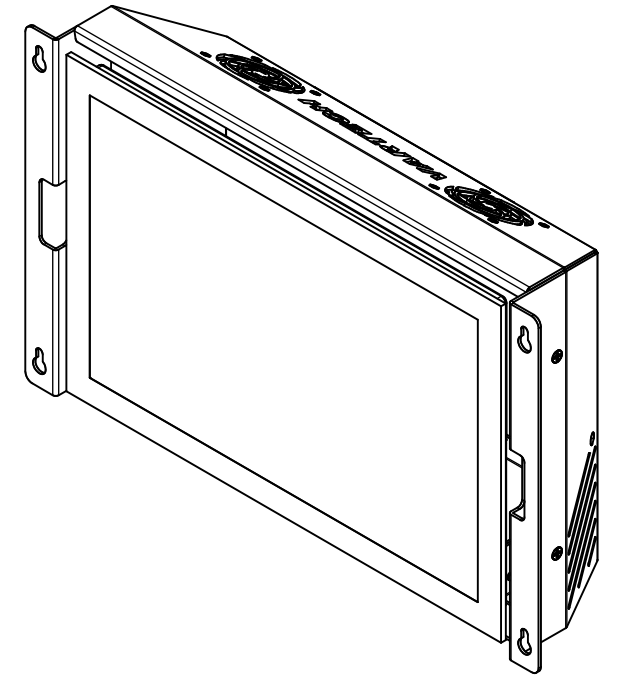
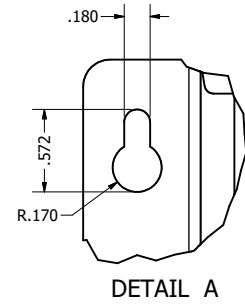
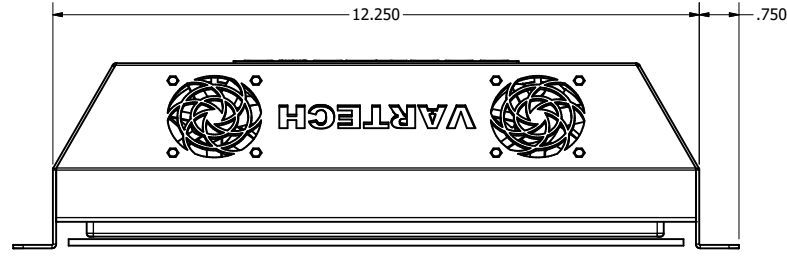

SEVERAL I/O AND POWER CONFIGURATIONS AVAILABLE

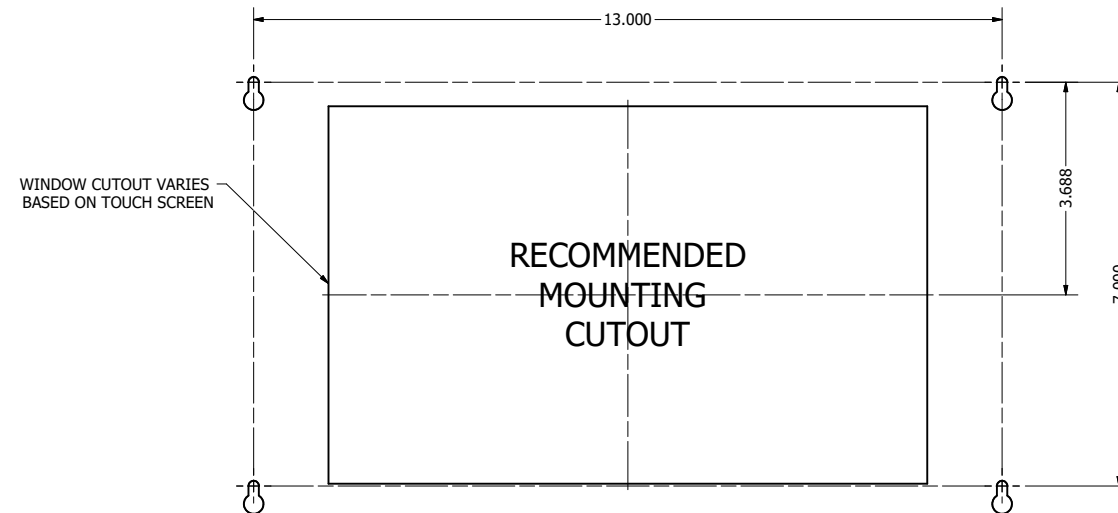

DRAWN BY: mwitham		8/18/2020		
USE WITH PRODUCT NUMBER				
MATERIAL & FINISH				TITLE
				OUTLINE DRAWING DIAMONDVUE 4
SHEET	SIZE	PART NUMBER	REV	
7 of 7	D	VTDV4#121cCHA	00	
TOLERANCES: .XX=-.01 .XXX=-.005				