

## DV4 43" Widescreen

VarTech's flagship DiamondVue series of touchscreen monitor displays and panel computers are available in various mechanical/mounting designs.

The adaptive design of DiamondVue monitors and panel computers enables the same mechanical footprint for standalone displays and panel computers alike, expanding versatility to a wider range of industrial, commercial, and military applications.

New clip mount bezel options offer a slimmer design, and displays are easily mounted without having to drill holes. Available with standard or sunlight readable LCD screens these screens are perfectly suited for improved visibility and operability of HMI interfaces and process controls.

### Standard Features:

- Industrial-grade LED back-lit LCD.
- Power input: 12 VDC, 9-36 VDC, or 90-264 VAC internal power supply
- Mounting configurations: panel with clips, VESA (300 mm VESA pattern)
- Operating temperature: -10° to 60° C (Extreme Temperature Package available depending on size. Please inquire.)
- Relative humidity: ≤ 90% to ≤ 95% (depending on mechanical build)
- Altitude: 10,000 ft MSL
- 2-year warranty

### Available Options:

- Dimming: Manual dimmer dial - 1000:1 dimming ratio, or auto-dimming
- Optical bonding (VBOND): adhering a cover glass, protective overlay, or touchscreen to the front surface of the LCD using an optical-grade silicone to increase solar reflectivity and ruggedness.
- Private labeling: company logo or corporate identity for OEM/VAR applications
- Coatings: custom powder coat, paint, and chemical resistant finishes
- Internal conformal coating: protection from moisture, dust, and corrosion
- Fanless design: solid-state components

### Computer Options:

- 1 × VGA, 1 × HDMI
- Operating system: Windows 10 Professional - 32 & 64-bit, Windows 10 Enterprise, Windows 7 - 32 & 64-bit, Linux (select versions of Linux supported)
- Additional and/or alternate I/O ports available: Please contact your sales representative
- Storage: HDD, SSD, removable drives, various capacities, multiple drives
- Expansions: PCI, PCIe, mPCIe, M.2, SIM card slot

### Dimensions (W × H × D):

Size	Panel with Studs Dimensions	VESA/RAM Dimensions	Rack Dimensions	Console & Console Extreme Dimensions	Panel with Clip Dimensions	Chassis Dimensions	Aspect Ratio	Brightness	Resolution
43" wide	NA	40.13" × 24" × 4.08"	NA	NA	40.75" × 24.63" × 4.08"	NA	16:9	500 nits 1500 nits ☀️	FHD 1920 × 1080 FHD 1920 × 1080

☀️ Sunlight readable LCD

DV4 dimensions differ from older models. If ordering a replacement unit please ask your sales representative for specifications.



Computer in black powder coat



Monitor in stainless steel



DV4 43" standard in black powder coated aluminum or stainless steel. Custom colored powder coating available.



### Computer Features:

- Embedded computer
- Operating system: Windows 10 Professional 64-bit (standard)
- 2 × 10/100/1000 Mbps LAN
- 1 × front bezel USB (Type-A or Type-C available on NEMA 4)

### Monitor Only Features:

- On Screen Display (OSD) controls

- ThinManager® thin client management
- Wireless connectivity: Bluetooth, WiFi, integrated router/WiFi repeater

### Monitor Only Options:

- 1 × front bezel USB pass-through, Type-A or C
- OSD button placement: OSD membrane control buttons can be mounted in alternate locations on front or rear of the display (front mounting options not available on all mechanical designs), or wired remote OSD
- OSD options: Bluetooth control, IR remote, programmable hotkeys, RS-232 OSD control (PC APP or serial commands)
- HD-SDI input add-on available
- Display options: USB failover, PiP
- Audio pass-through
- Integrated KVM extender
- Legacy video support: 15 kHz to 30 kHz, and SOG/composite/separate horizontal and vertical sync

Environmental Functional Upgrade Packages available. See next page.

## Specification Chart:

						Referenced in tables below			
Size	Brightness	Resolution	Touchscreen	Viewing Angle	Contrast	Available Monitor I/O Ports	Available Computer I/O Ports	Power Consumption** (Calculated at 12 V DC)	Approximate Weight** (Based on VESA Mount)
43" wide	500 nits 1500 nits	FHD 1920 × 1080 FHD 1920 × 1080	NA	89°/89°/89°/89° 89°/89°/89°/89°	3000:1 4000:1	C, D	E, F, G, I	≈ 66 W ≈ 155 W	≈ 65 Lbs

\*\* Power consumption and approximate weight based on aluminum monitor

## LCD Controller Board Specifications:

Option	Resolution	Available Video I/O Ports	Horizontal/Vertical Scan
C	Up to 1920 × 1200, 8-Bit	1 × HDMI, 1 × Display Port 1 × VGA	60 Hz up to 1920 × 1200
D	Up to 1920 × 1200, 10-bit	1 × HDMI, 1 × DVI, 1 × VGA 1 × Composite (PAL/NTSC)	60 Hz up to 1920 × 1200

Non-standard controller boards and I/O ports available depending on panel size. Please inquire.

## Standard Motherboard Specifications:

Option	Processor	Memory	Storage Drive	Operating System	Available I/O Ports
E*	Intel J1900 Quad-Core	Up to 8 GB	1 × SATA-300 1 × mSATA/SIM	Win 7: 32/64-bit, Win 10: 32/64-bit	2 × RS-232/422/485 3 × USB 2.0 1 × USB 3.0 2 × LAN PS/2 KB/M
F*	Intel Atom E3845	Up to 8 GB	1 × SATA-300 1 × CFAST	Win 7: 32/64-bit, Win 10: 32/64-bit	2 × RS-232/422/485 3 × USB 2.0 1 × LAN
G*	i5-7300U	Up to 16 GB	1 × SATA-300 1 × mSATA/SIM	Win 10: 64-bit	2 × RS-232/422/485 4 × USB 3.0 2 × LAN
H	Celeron G3900TE, i3-6100TE, i5-6500TE, i7-6700TE	Up to 32 GB	3 × SATA-600 1 × mSATA	Win 10: 64-bit	1 × RS-232/422/485 1 × RS-232 4 × USB 3.0 1 × DisplayPort 2 × LAN

Non-standard motherboards and processors available depending on panel size. Please inquire.

Motherboard selection may affect operational temperature

\* Fanless operation available

## Standard I/O Connectors:

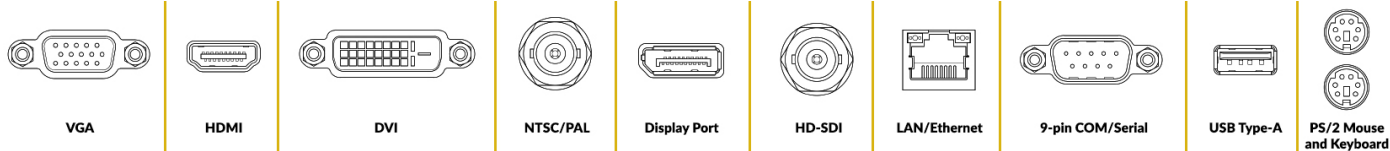

## Available Ruggedized I/O Connectors:

M8/M12/M23: industrial automation, vibration and shock-resistant

MIL-DTL 38999: military standard, sealed, vibration and shock-resistant quick-coupling circular locking connectors

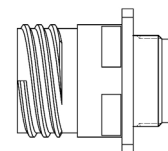
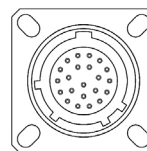
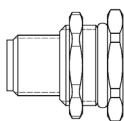

## Mounting Option Examples:

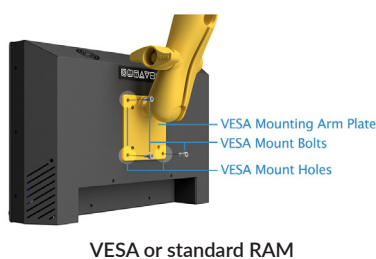
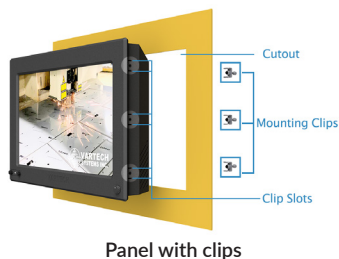

## Environmental Functional Upgrade Packages:

VarTech's Environmental Functional Upgrade Packages allow for custom COTS solutions using standard feature sets.

High Bright Sunlight Readable Package	Component Ruggedization Package	Extreme Temperature Package (-40° C to 70° C)
<ul style="list-style-type: none"> <li>High luminance LED backlights</li> <li>Proprietary optical film stack</li> <li>Optical bonding of protective window or touchscreen to LCD</li> <li>Anti-reflective coatings</li> <li>Brightness levels ranging from 700 nits to 1500 nits (depending on screen size)</li> <li>Dimming: Manual dimmer dial - 1000:1 dimming ratio, or auto-dimming</li> <li>Optional: backlight kill switch</li> </ul>	<ul style="list-style-type: none"> <li>Shock/Vibration resistance: video controller board or motherboard, cable assemblies/connectors</li> <li>Potted components where applicable</li> <li>Vibration dampening</li> <li>Optical bonding of protective window or touchscreen to LCD</li> <li>MIL-DTL 38999 I/O connectors (not available on hazardous area models)</li> </ul> <p>Designed to meet tolerances specified by select subcategories of MIL-STD 810F and/or DEFSTAN 00-35 inclusive of Part 3 Issue 4.</p>	<ul style="list-style-type: none"> <li>Integrated heater and thermostat</li> <li>Wide temperature LCD panel</li> <li>Harsh environment video controller board or motherboard/SSD/RAM</li> <li>Optional: heat-reflective powder coat</li> <li>Optional: uninterrupted wide temperature dual Power Supply Unit (PSU) system</li> </ul>
EMI/EMC 461 FS Package	NVIS Dual Mode Compatibility Package	Vandal/Impact Resistant Package
<ul style="list-style-type: none"> <li>EMI protection front surface</li> <li>Protective window or touchscreen equipped with 8 Ohm ITO for surface ship limits and 100 OPI SSTL mesh or 160 OPI copper printed mesh for Army ground limits</li> <li>Chromated metal and EMI copper conductive tape to assure conductivity of ITO/busbar and enclosure</li> <li>Enhanced EMI conductive gaskets for MIL-STD 461 protection while maintaining seal up to IP66 at front panel surface</li> <li>CE101, CE102, CS101, CS106, CS114, CS115, CS116, RE101, RE102, RS101, RS103 (Designed to meet based on similar VarTech Systems Designs)</li> </ul> <p>This package is typically coupled with a flush or panel mount design</p>	<ul style="list-style-type: none"> <li>NVIS MIL-STD 3009 class B green (night mode)</li> <li>Brightness levels from 4 nits to 30 nits (night mode)</li> <li>Toggle between day/night mode via the one-touch tactile button</li> <li>Dimming: Manual dimmer dial - 1000:1 dimming ratio, or auto-dimming</li> <li>ITAR restrictions apply</li> <li>Optional: backlight kill switch</li> </ul>	<ul style="list-style-type: none"> <li>Impact resistant protective overlay glass</li> <li>8H abrasion-resistant overlay glass</li> <li>Chemical and stain resistant glass and surfaces</li> <li>Tamper-proof conduit connectors</li> <li>Optional: PCAP touchscreen</li> </ul>

Railway Ruggedization Package (Built to meet EN50155)
<ul style="list-style-type: none"> <li>24, 48, 72, 96, and 110 VDC Nominal Inputs Available (Complies with EN50155, Meets EN50121-3-2)</li> <li>Universal Power Input Screw Terminal Connector</li> <li>Vibration dampening</li> <li>Reverse polarity protection</li> <li>Fanless</li> <li>Fuseless</li> <li>Protective coating on all Circuit Boards</li> <li>Optical bonding of protective window or touchscreen to LCD</li> <li>Optional: M-Series connectors or D38999 connectors</li> </ul>

## DiamondVue Core Model Number Breakdown:

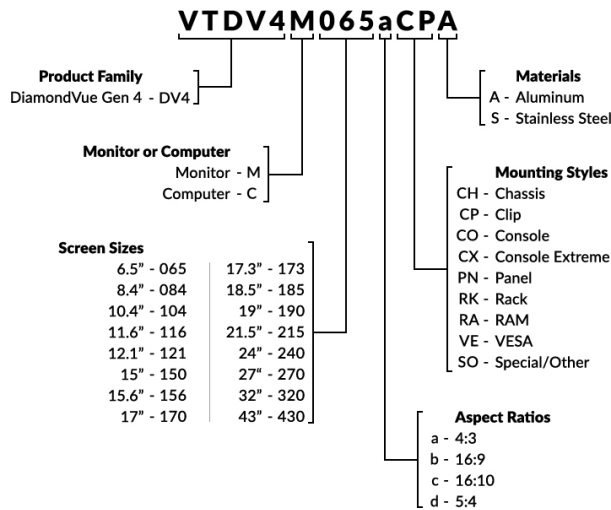

Over 30 years of rugged HMI and industrial computer manufacturing experience

