

# 32.0" CHASSIS MOUNT (Monitor or Panel Computer)

PRELIMINARY DRAWING  
DIMENSIONS ARE SUBJECT TO CHANGE

REVISION HISTORY			
REV	DATE	INITIALS	DESCRIPTION
00	11/27/19	MAW	INITIAL RELEASE

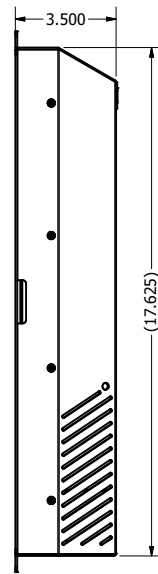
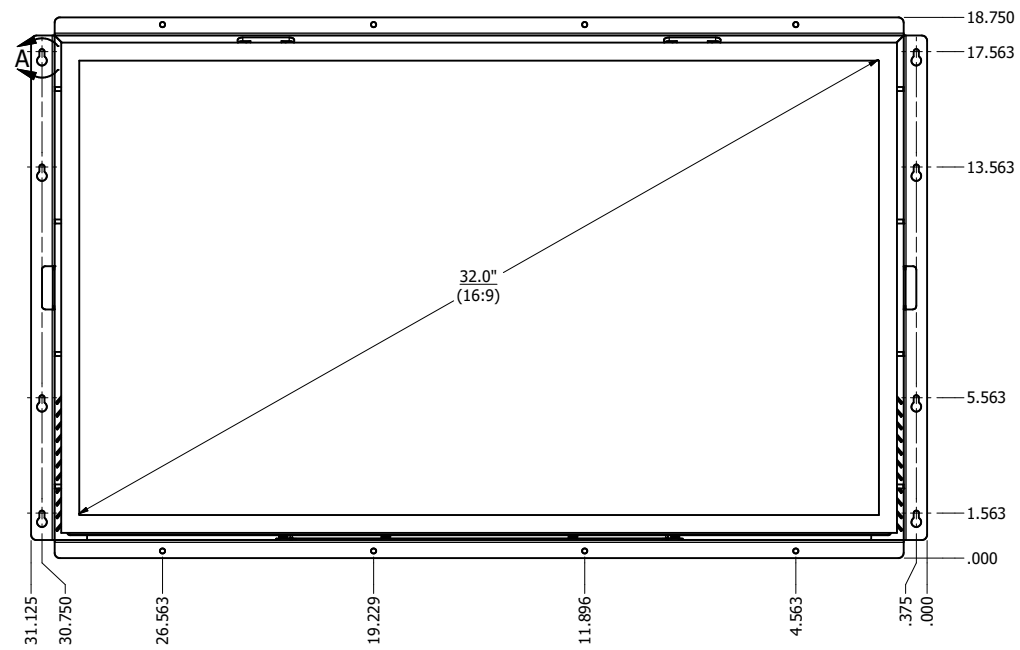
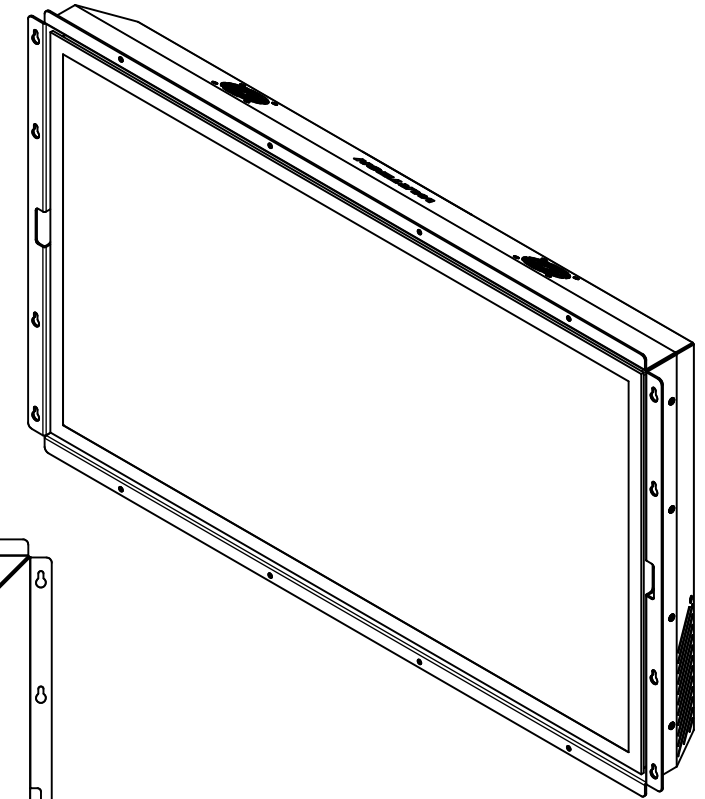
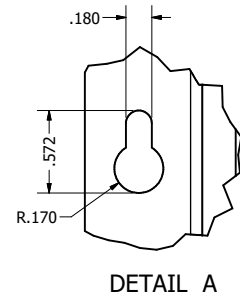
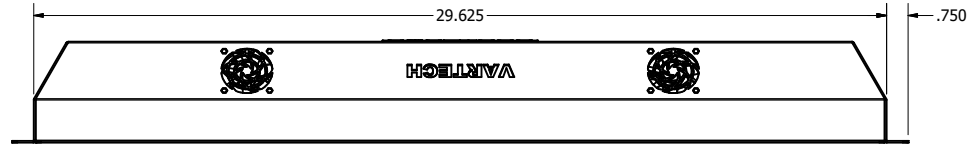

OPTIONAL OSD CONTROLS ON REAR PANEL FOR MONITORS ONLY

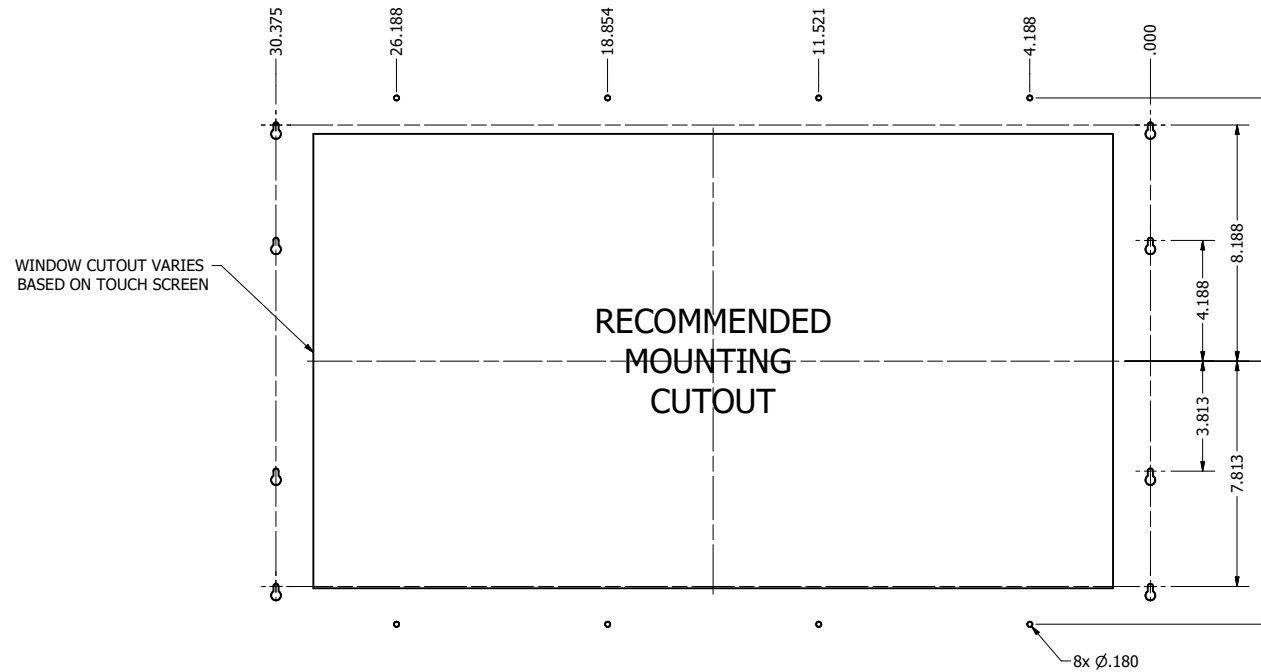
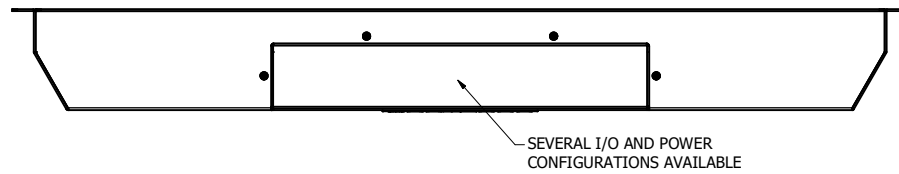
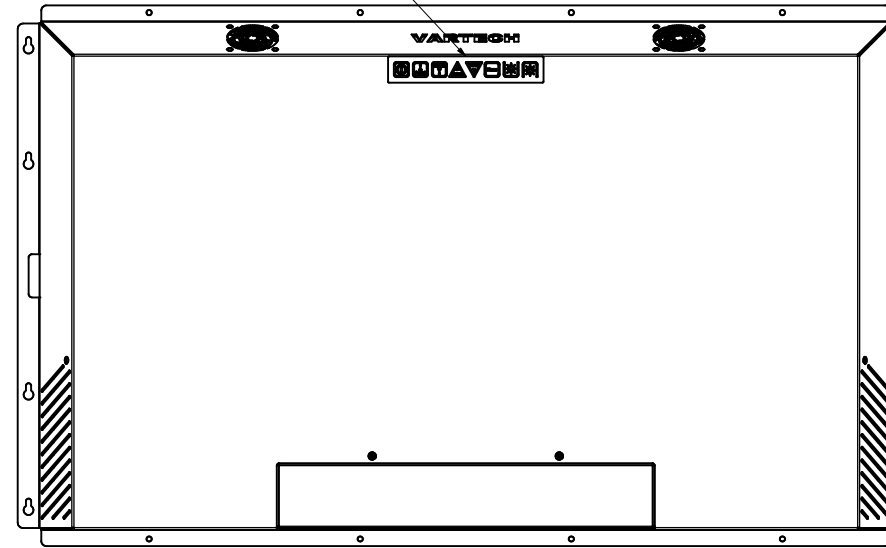

DRAWN BY: mwitham		8/18/2020		
USE WITH PRODUCT NUMBER				
MATERIAL & FINISH				TITLE
				OUTLINE DRAWING DIAMONDVUE 4
SHEET	SIZE	PART NUMBER	REV	
6 of 6	D	VTDV4#320bCHA	00	
TOLERANCES: .XX=.01 .XXX=.005				