

21.5" PANEL MOUNT (Monitor or Panel Computer)

PRELIMINARY DRAWING
DIMENSIONS ARE SUBJECT TO CHANGE

REVISION HISTORY			
REV	DATE	INITIALS	DESCRIPTION
00	11/27/19	MAW	INITIAL RELEASE

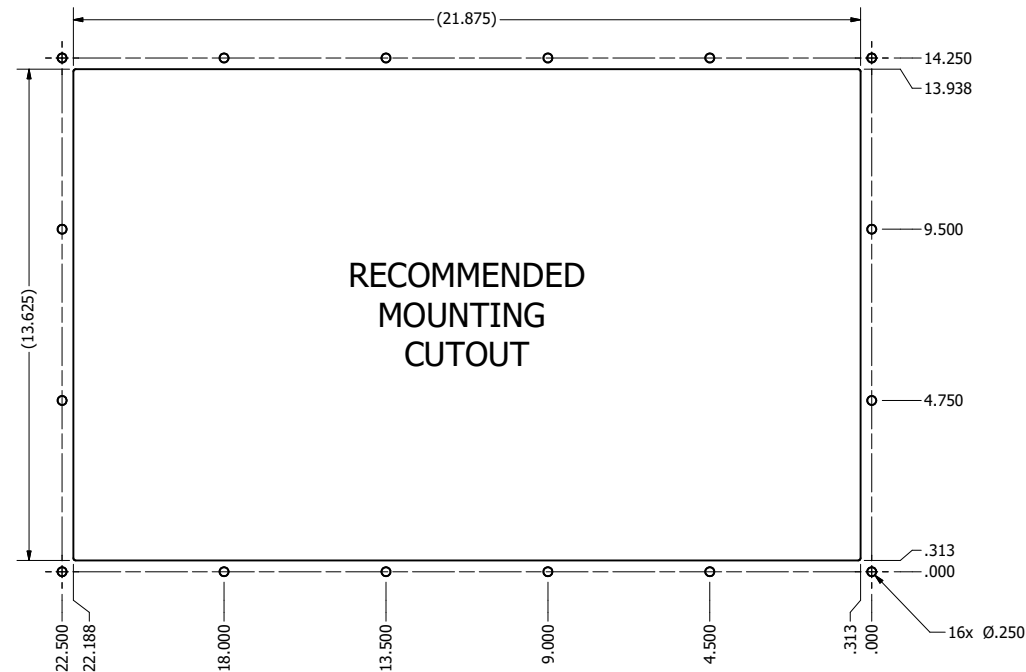
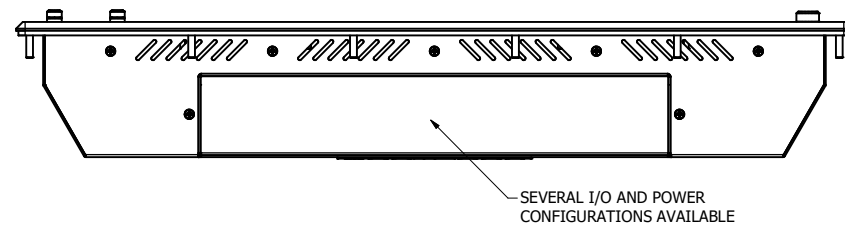
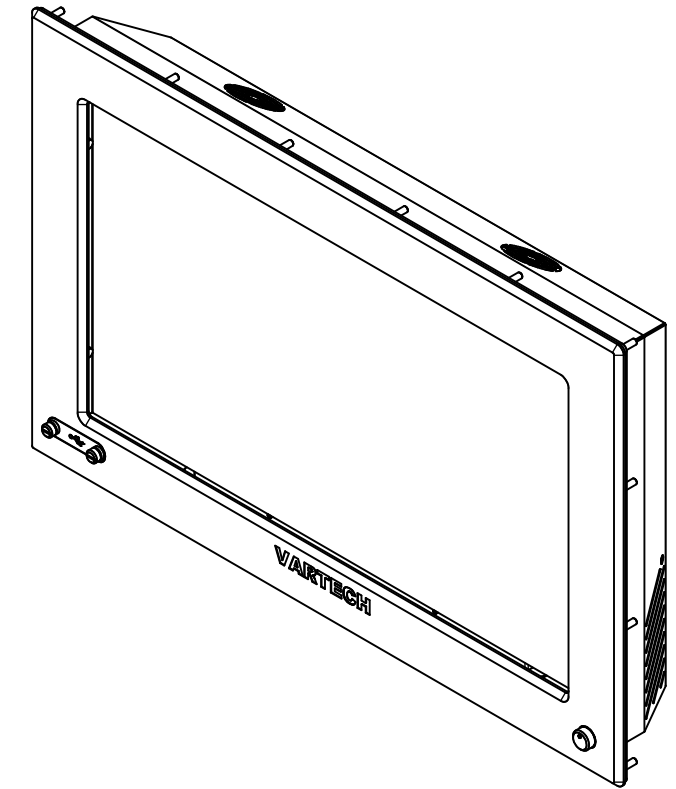
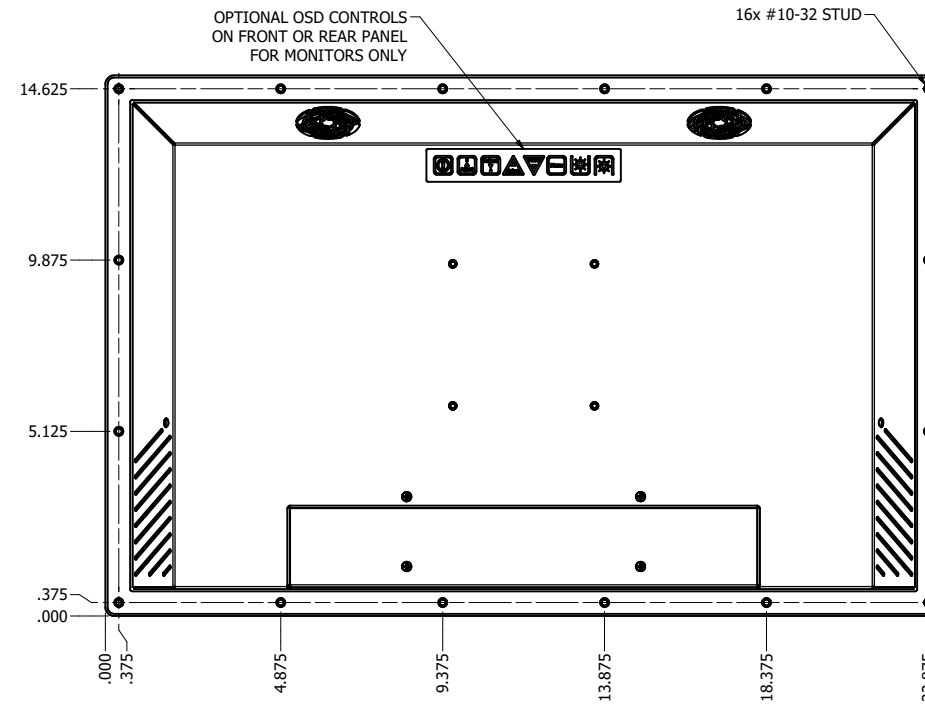
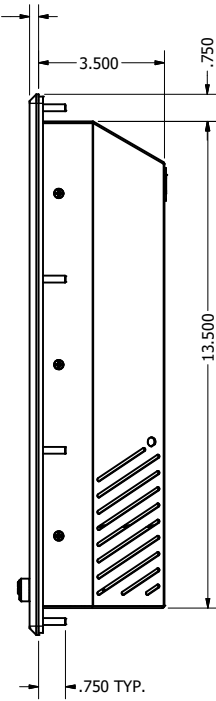
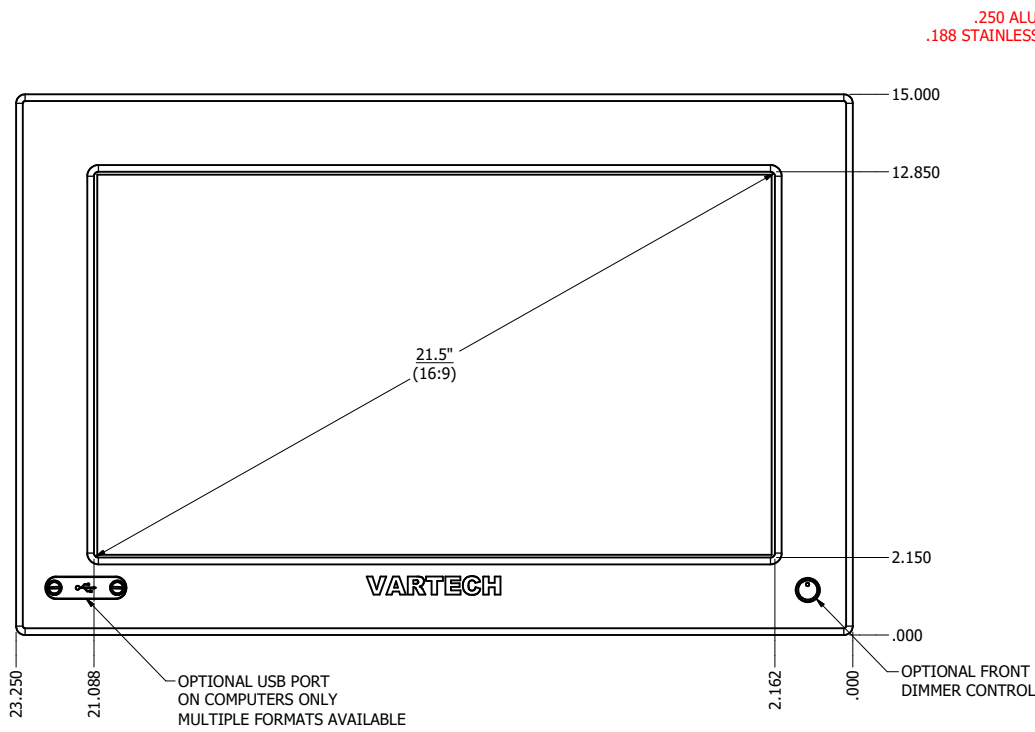
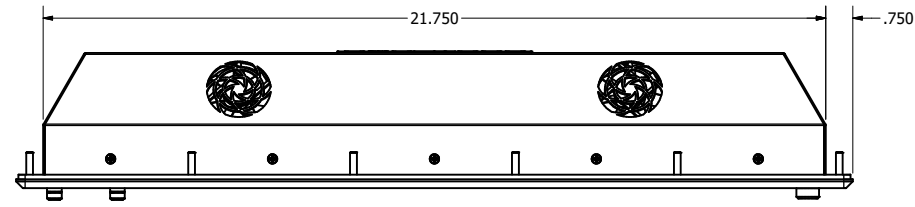

DRAWN BY:		USE WITH PRODUCT NUMBER		
MATERIAL & FINISH		TITLE		
		OUTLINE DRAWING DIAMONDVUE 4		
SHEET	SIZE	PART NUMBER	REV	
1 of 6	D	VTDV4#215bPN#	00	
TOLERANCES: .XX=-.01 .XXX=-.005				