

21.5" CHASSIS MOUNT (Monitor or Panel Computer)

PRELIMINARY DRAWING
DIMENSIONS ARE SUBJECT TO CHANGE

| REVISION HISTORY | | | |
|------------------|----------|----------|-----------------|
| REV | DATE | INITIALS | DESCRIPTION |
| 00 | 11/27/19 | MAW | INITIAL RELEASE |

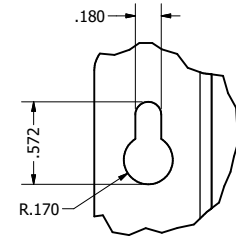
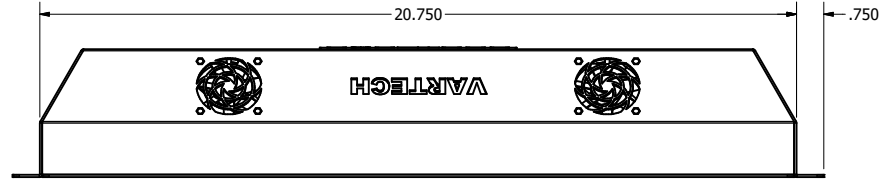

DETAIL A

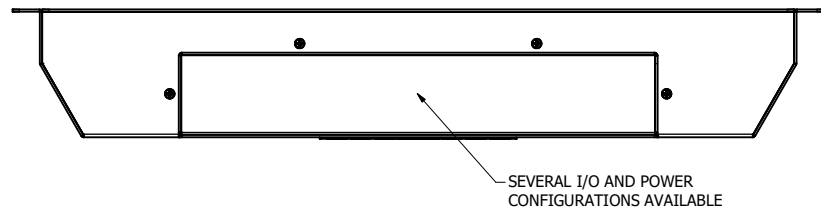
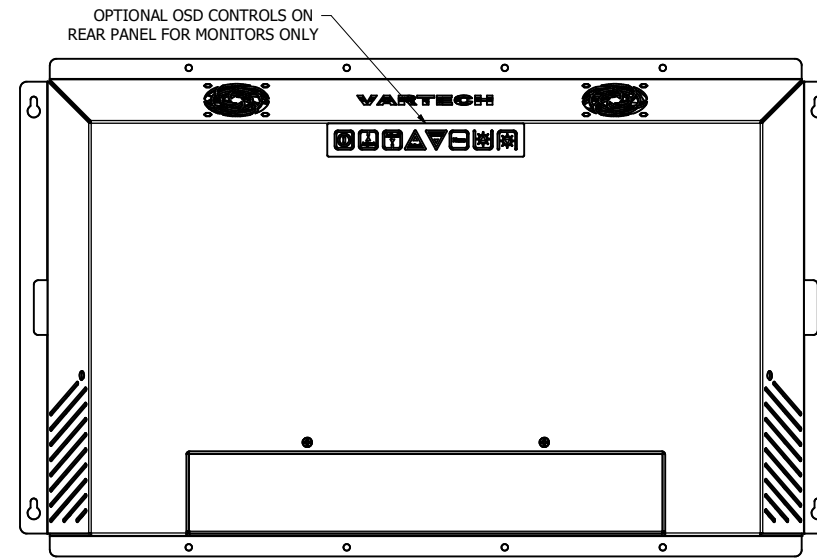
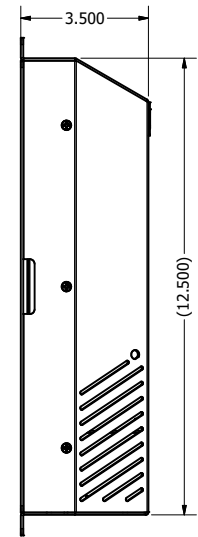
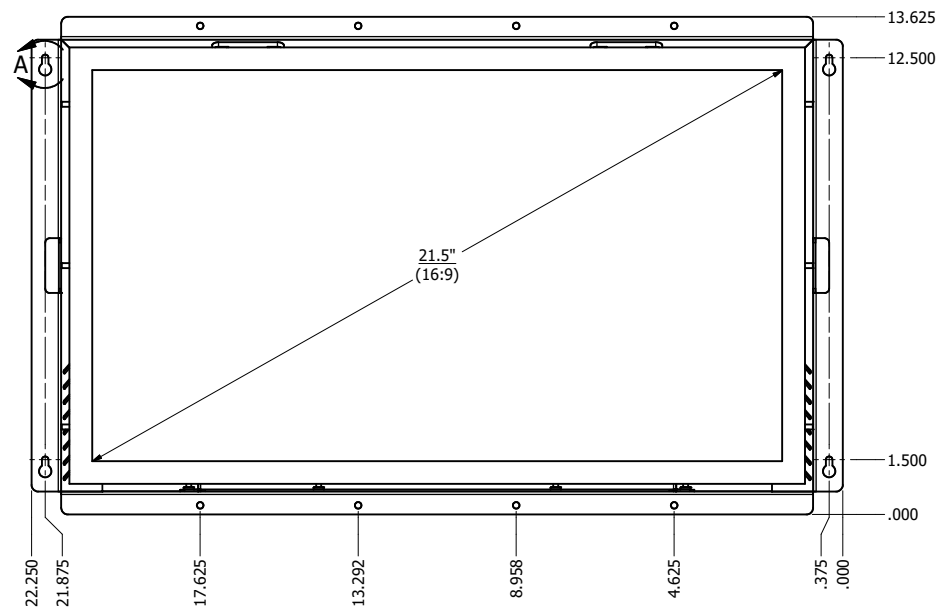
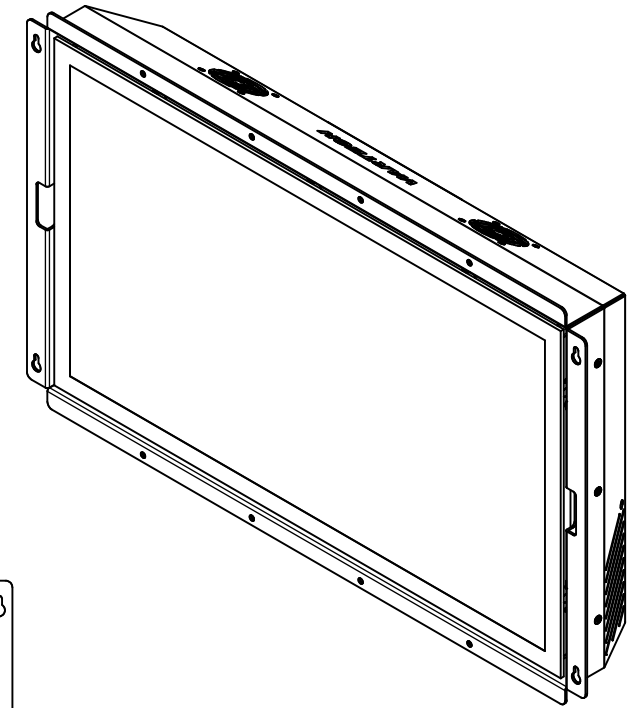

SEVERAL I/O AND POWER CONFIGURATIONS AVAILABLE

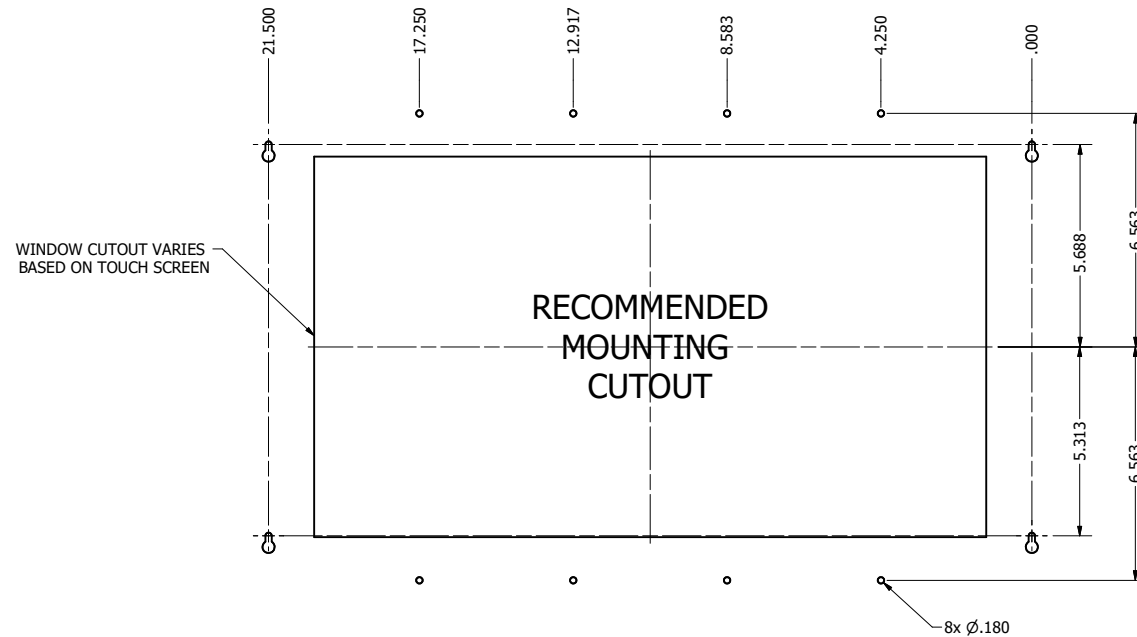

| | | | | |
|-------------------------------|------|---------------|-----|---------------------------------|
| DRAWN BY: mwitham | | 8/18/2020 | | |
| USE WITH PRODUCT NUMBER | | | | |
| MATERIAL & FINISH | | | | TITLE |
| | | | | OUTLINE DRAWING DIAMONDVUE 4 |
| SHEET | SIZE | PART NUMBER | REV | |
| 6 of 6 | D | VTDV4#215bCHA | 00 | |
| TOLERANCES: .XX=.01 .XXX=.005 | | | | |