

18.5" CHASSIS MOUNT (Monitor or Panel Computer)

PRELIMINARY DRAWING
DIMENSIONS ARE SUBJECT TO CHANGE

| REVISION HISTORY | | | |
|------------------|----------|----------|-----------------|
| REV | DATE | INITIALS | DESCRIPTION |
| 00 | 11/27/19 | MAW | INITIAL RELEASE |

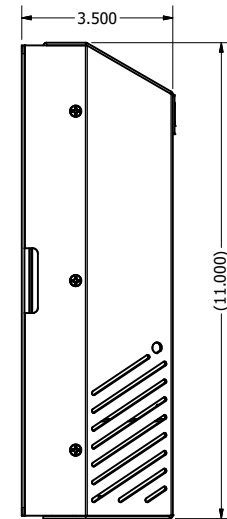
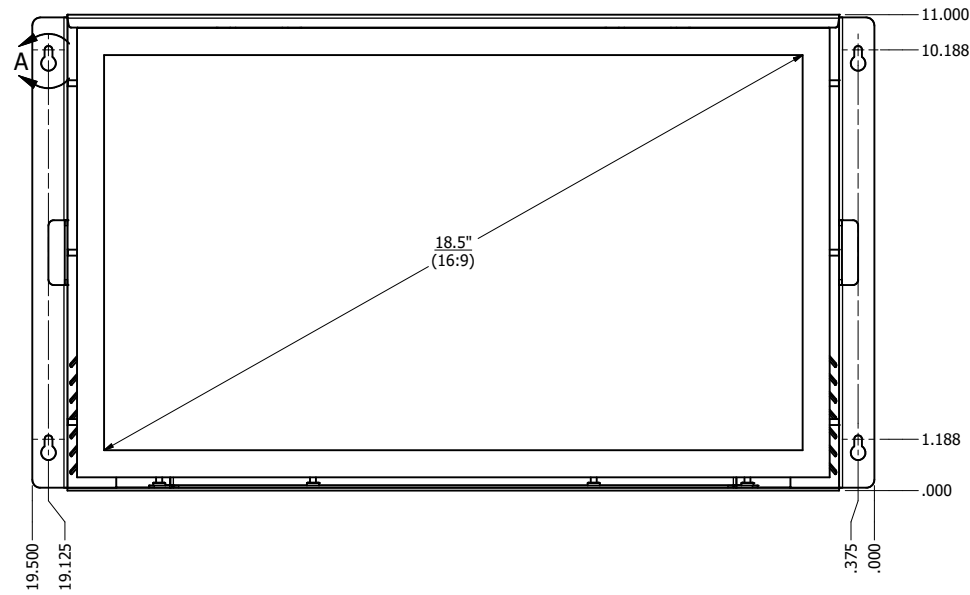
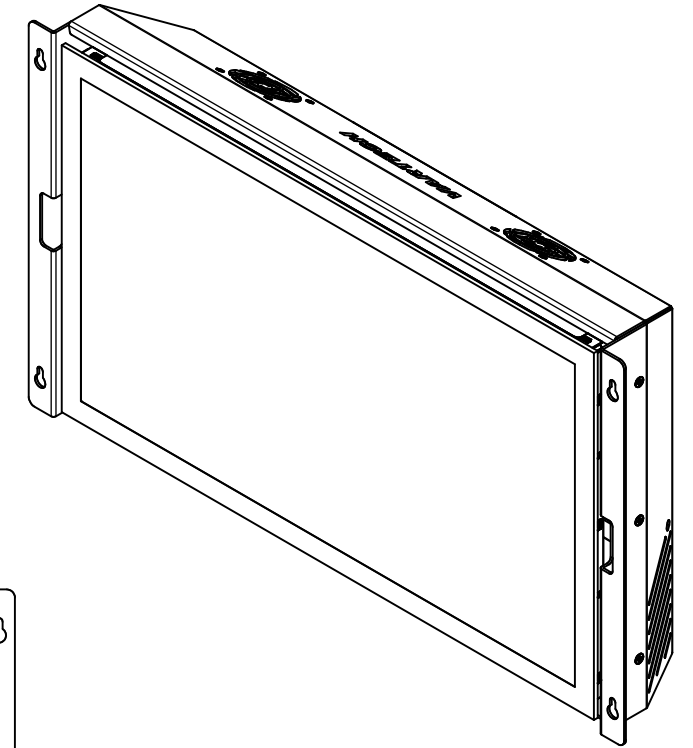
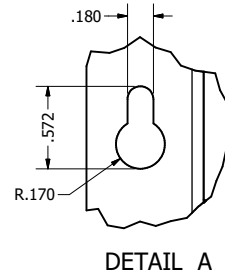
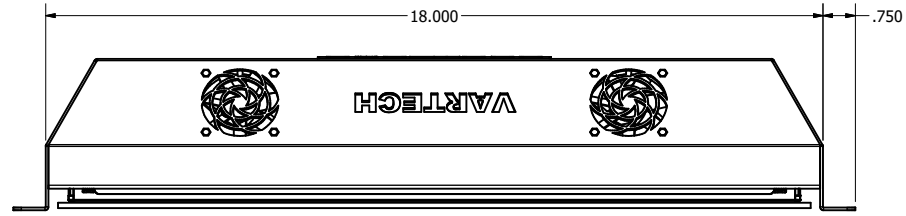

OPTIONAL OSD CONTROLS ON REAR PANEL FOR MONITORS ONLY

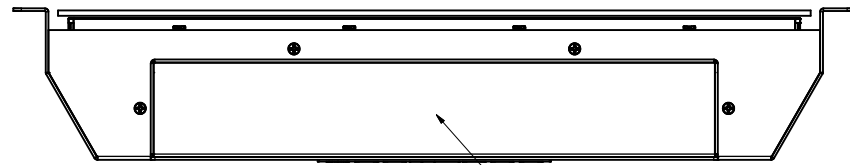
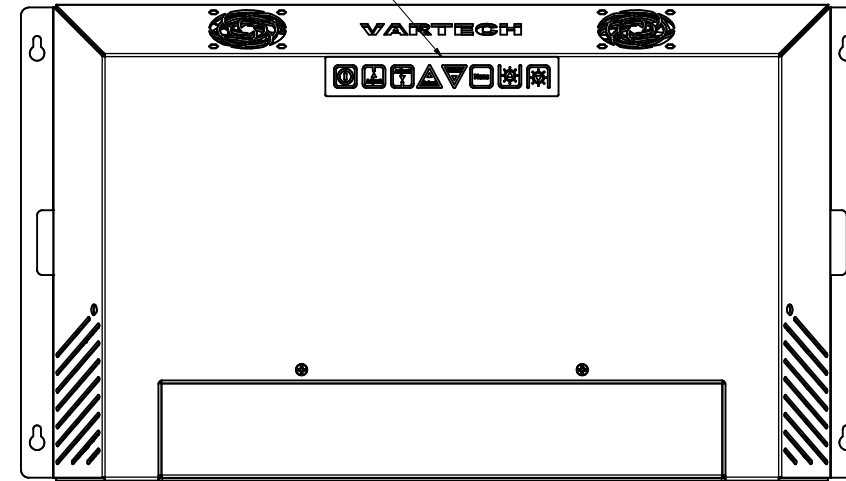

SEVERAL I/O AND POWER CONFIGURATIONS AVAILABLE

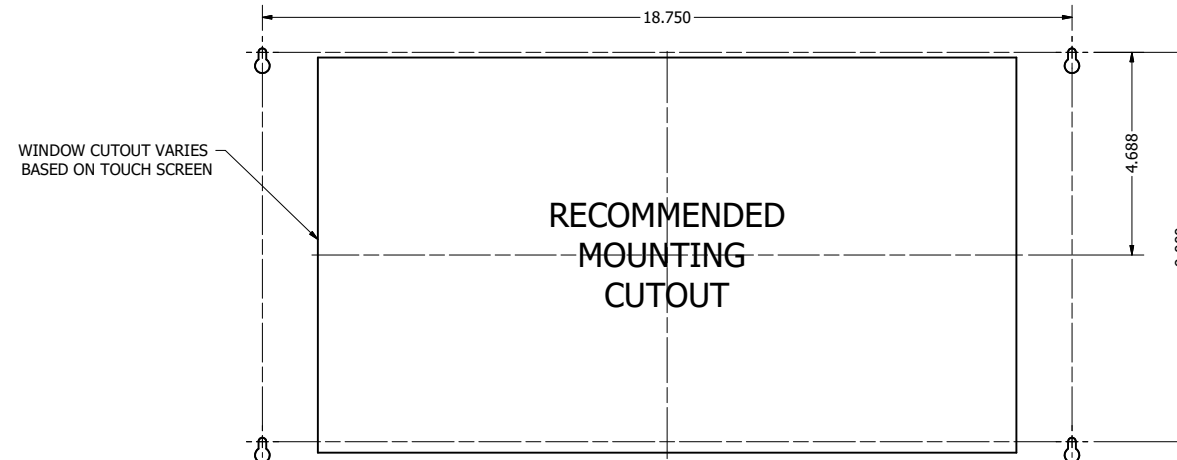

| | | | | | |
|-------------------------------|------|---------------|-----|-----------------|--|
| DRAWN BY: mwitham | | 8/18/2020 | | | |
| USE WITH PRODUCT NUMBER | | | | | |
| MATERIAL & FINISH | | | | TITLE | |
| | | | | OUTLINE DRAWING | |
| | | | | DIAMONDVUE 4 | |
| SHEET | SIZE | PART NUMBER | REV | | |
| 7 of 7 | D | VTDV4#185bCHA | 00 | | |
| TOLERANCES: .XX=.01 .XXX=.005 | | | | | |