

17.3" VESA MOUNT (Monitor or Panel Computer)

PRELIMINARY DRAWING
DIMENSIONS ARE SUBJECT TO CHANGE

REVISION HISTORY			
REV	DATE	INITIALS	DESCRIPTION
00	11/27/19	MAW	INITIAL RELEASE

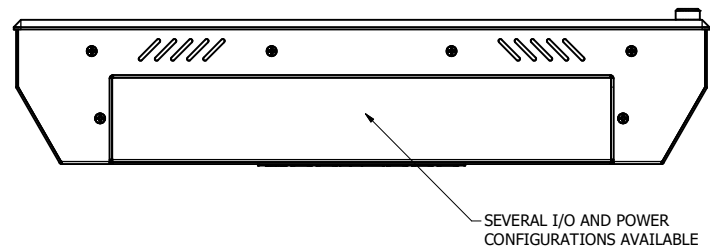
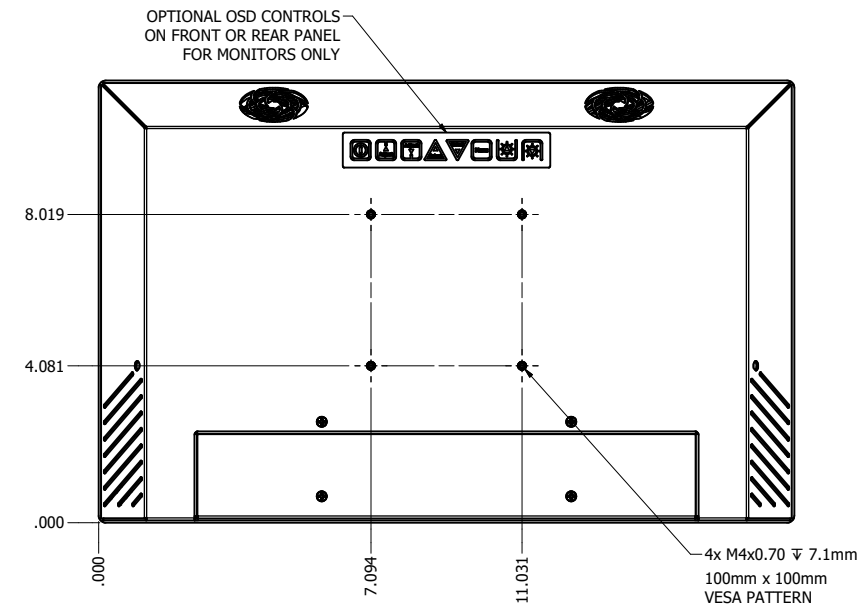
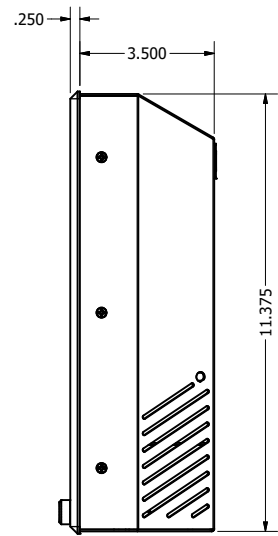
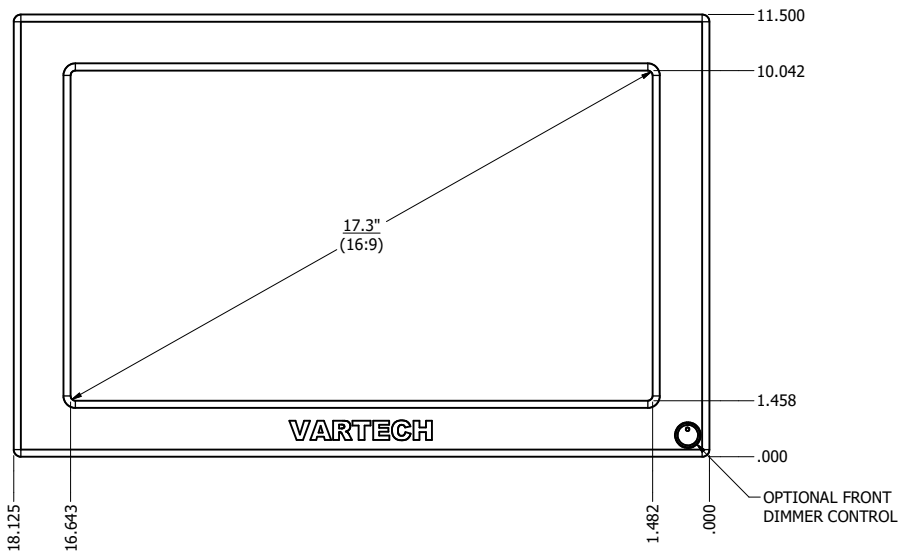
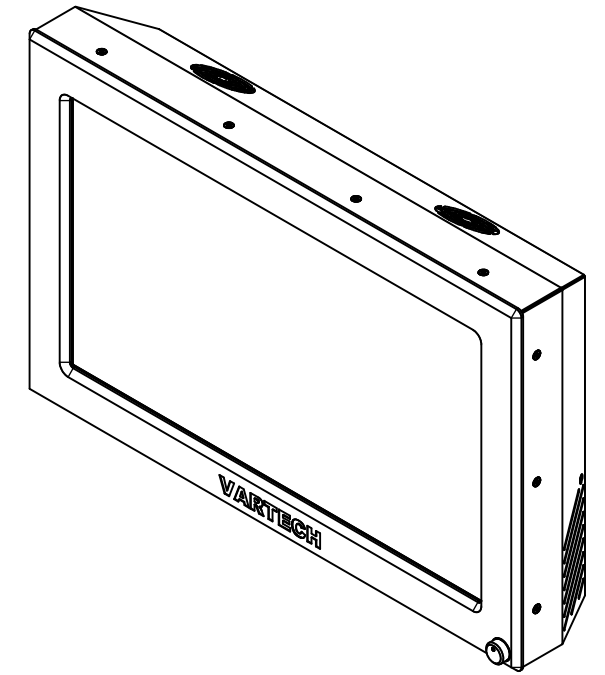
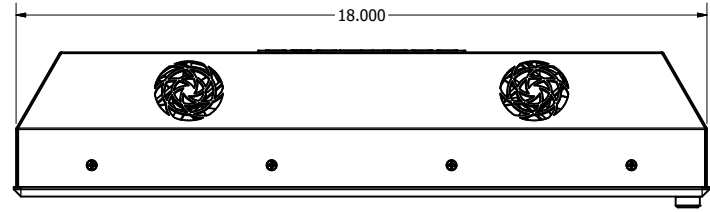

DRAWN BY:		USE WITH PRODUCT NUMBER		
MATERIAL & FINISH		TITLE		
TOLERANCES: .XX=.01 .XXX=.005		SHEET 2 OF 6		OUTLINE DRAWING DIAMONDVUE 4
		SIZE D	PART NUMBER VTDV4#173bVEA	REV 00