

10.4" CONSOLE MOUNT (Monitor or Panel Computer)

PRELIMINARY DRAWING
DIMENSIONS ARE SUBJECT TO CHANGE

REVISION HISTORY			
REV	DATE	INITIALS	DESCRIPTION
00	11/27/19	MAW	INITIAL RELEASE

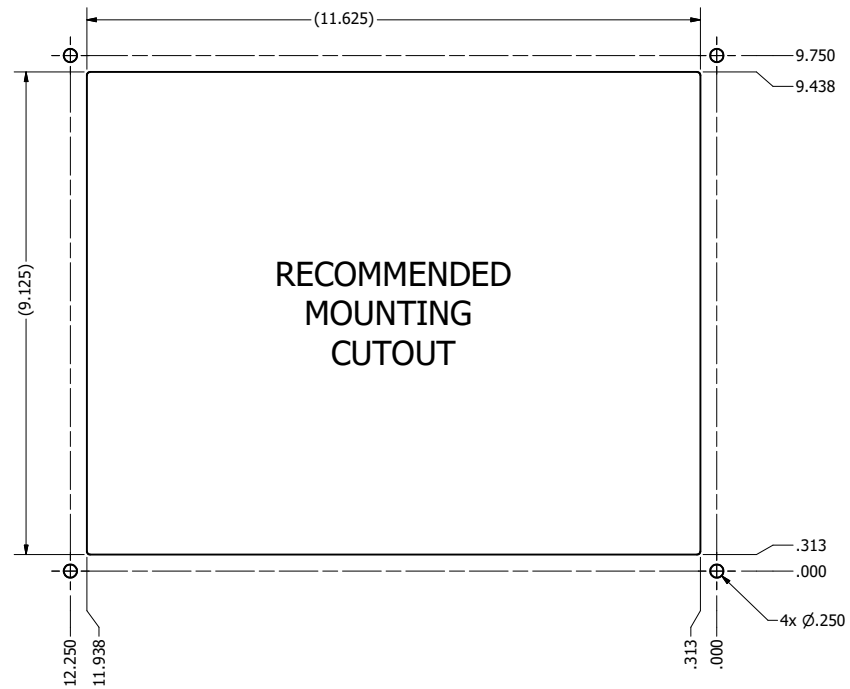
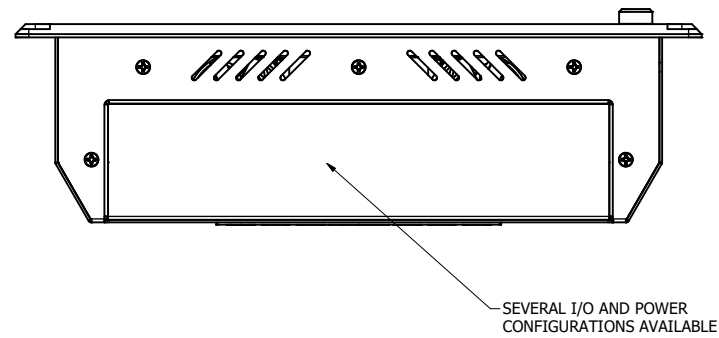
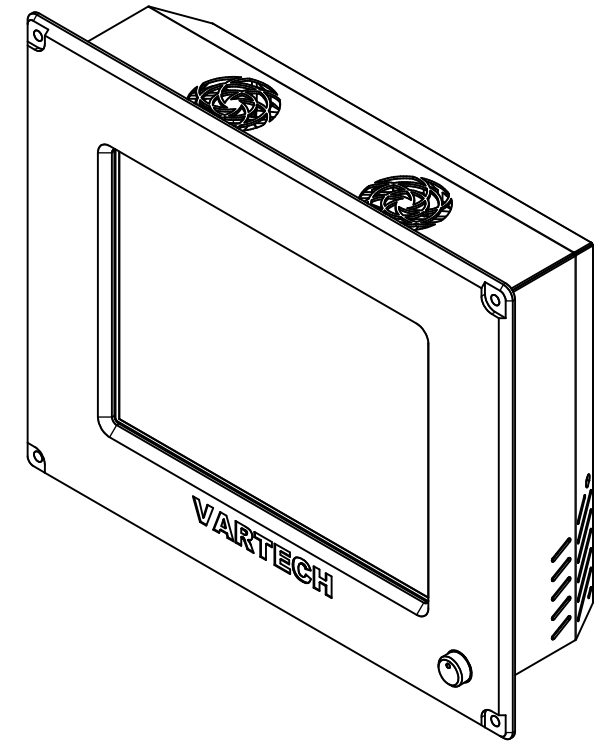
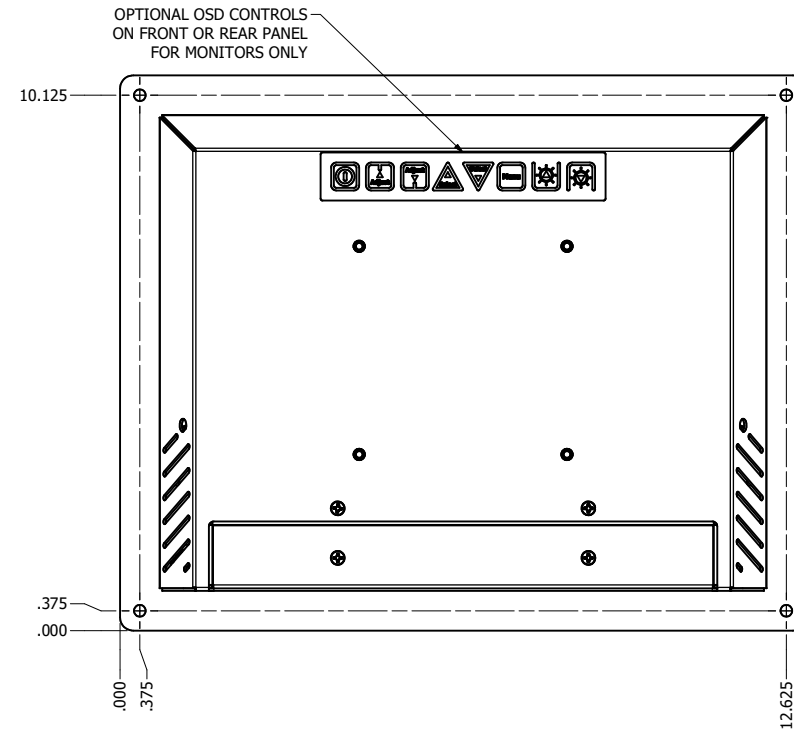
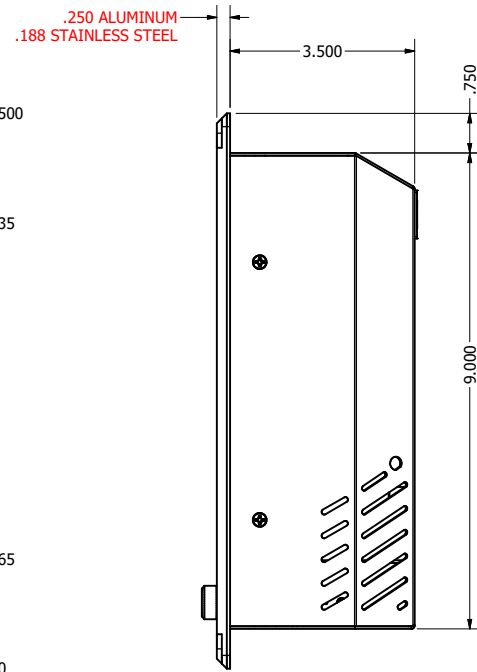
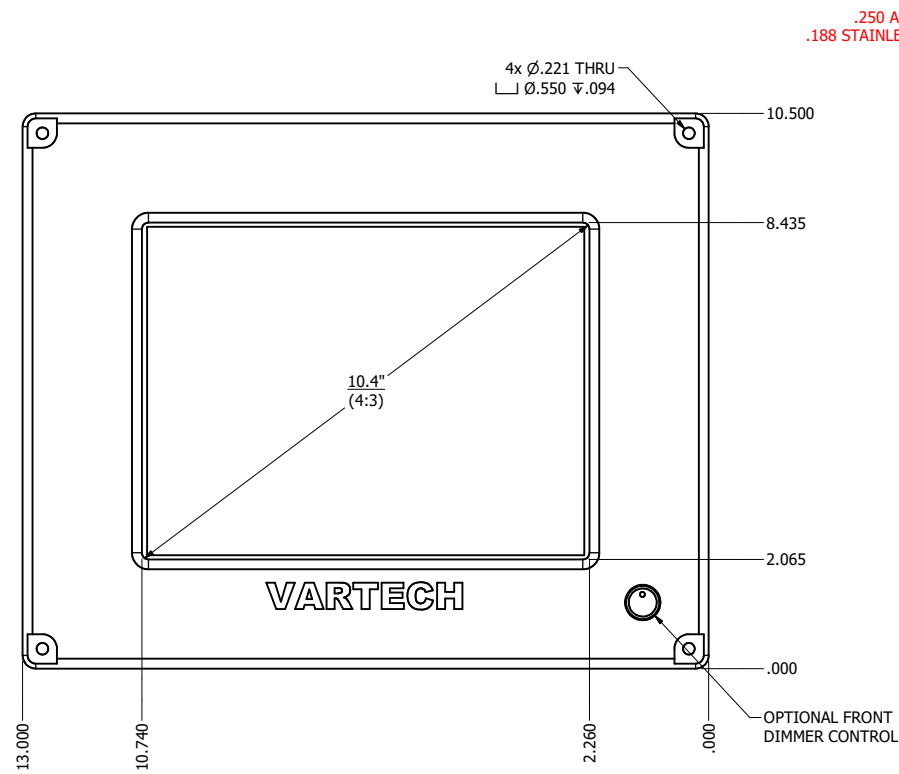
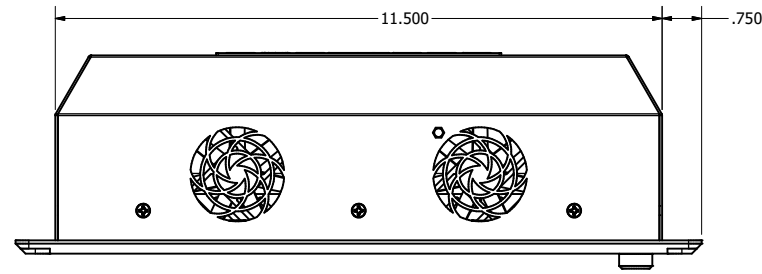

DRAWN BY: mwitham		11/26/2019		
USE WITH PRODUCT NUMBER				
MATERIAL & FINISH				TITLE
				OUTLINE DRAWING DIAMONDVUE 4
SHEET	SIZE	PART NUMBER	REV	
5 of 7	D	VTDV4#104aCO#	00	
TOLERANCES: .XX=-.01 .XXX=-.005				