

10.4" CLIP MOUNT (Monitor or Panel Computer)

PRELIMINARY DRAWING
DIMENSIONS ARE SUBJECT TO CHANGE

REVISION HISTORY			
REV	DATE	INITIALS	DESCRIPTION
00	11/27/19	MAW	INITIAL RELEASE

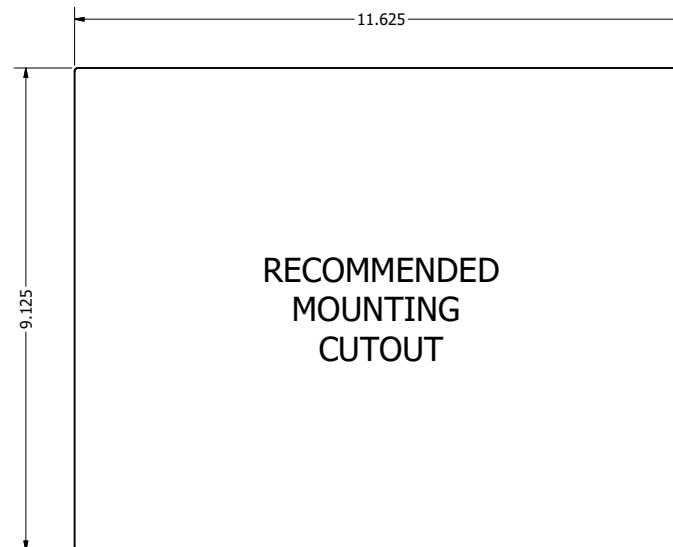
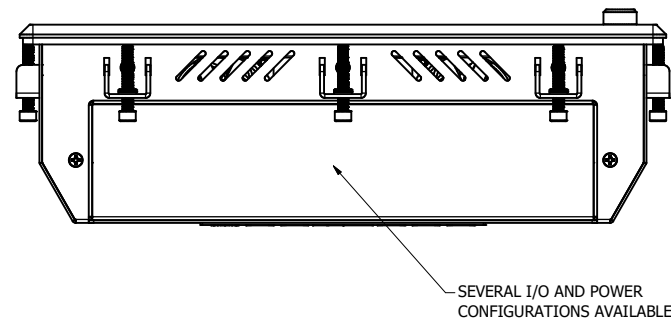
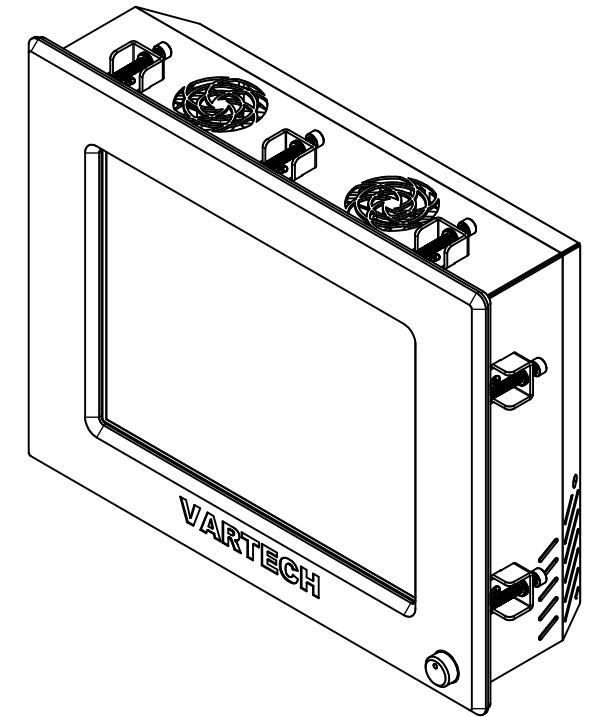
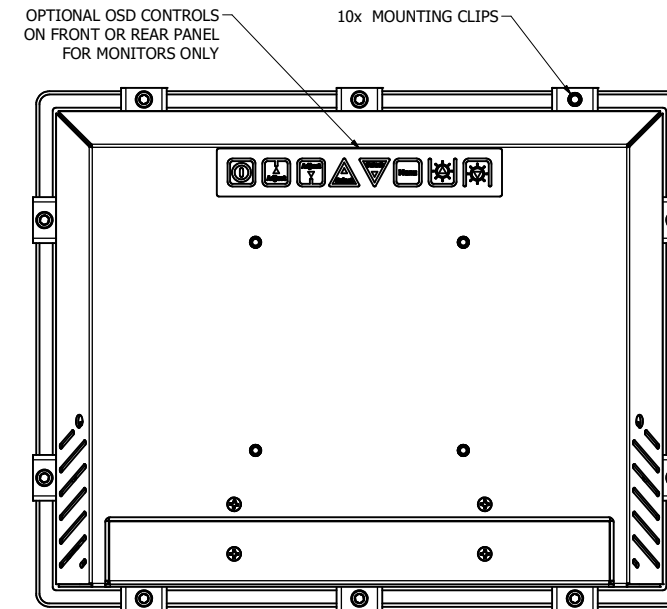
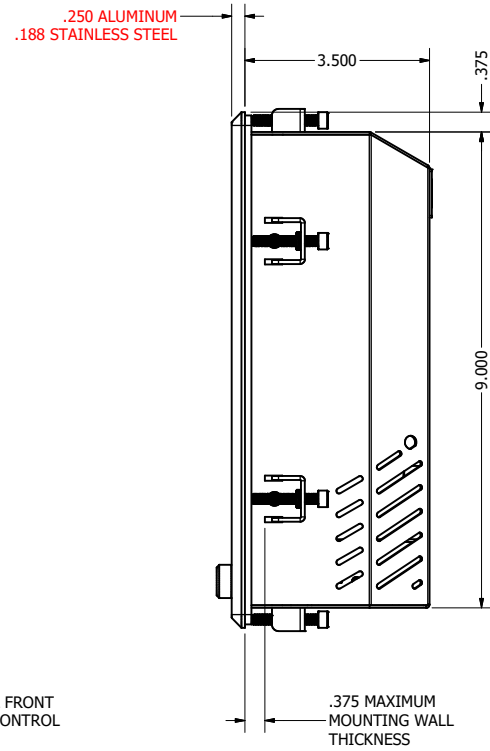
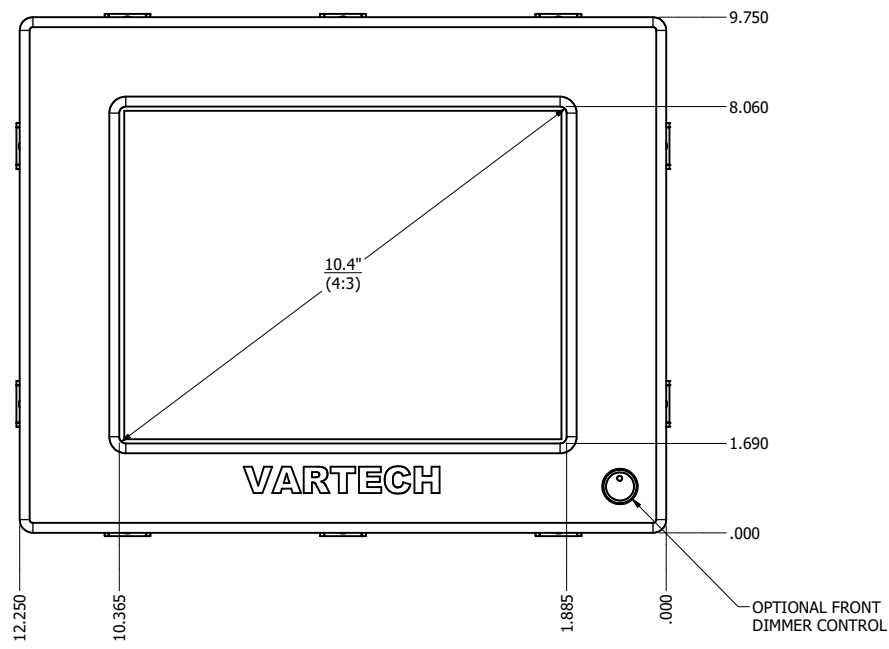
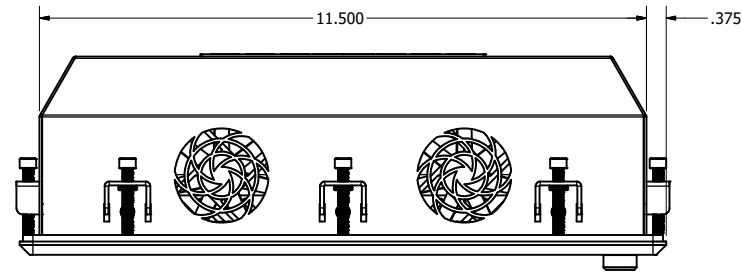

DRAWN BY: mwitham		11/26/2019			
USE WITH PRODUCT NUMBER					
MATERIAL & FINISH				TITLE	
				OUTLINE DRAWING DIAMONDVUE 4	
SHEET	SIZE	PART NUMBER	REV		
6 of 7	D	VTDV4#104aCP#	00		
TOLERANCES: .XX=-.01 .XXX=-.005					